



ASR
American Systems
REGISTRAR
ISO 9001

Member
NGA
National Glass
Association
U.S.A.



鋼國工業股份有限公司
GANG GWO INDUSTRIAL CO., LTD.

COMMERCIAL DOOR HARDWARE



GANG GWO INDUSTRIAL CO., LTD.

NO.6, Yuanshi St, Dajhou Village, Pingtung City 90093, Taiwan, R.O.C
E-mail: service@gangwo.com.tw
TEL: 886-8-7556651 Export: 886-8-7556631 FAX: 886-8-7556653~2
www.gangwo.com.tw

Material	Material No.	Cover Finish
Stainless Steel	SUS304	PSS,BSS,PVD
	SUS316	
Aluminium	1050	AL,CL,DU,DB
Brass	C2680	PB,BSB

Maximum Door Weight: 100kgs(220 lbs)
 Maximum Door Width: 1100mm(43")
 For 10mm(3/8")~12mm(1/2") Glass
 A dimensions: 70mm(2-3/4") and 65mm(2-9/16")

- (PSS:Polished Stainless Steel
- (BSS:Brushed Stainless Steel
- (PVD:Polished Zirconium
- (AL:Brushed Aluminium Anodizing
- (CL:Matt Aluminium Anodizing
- (DU:Duranodic Aluminium Anodizing
- (DB:Brushed Duranodic Aluminium Anodizing
- (PB:Polished Brass
- (BSB:Brushed Satin Brass

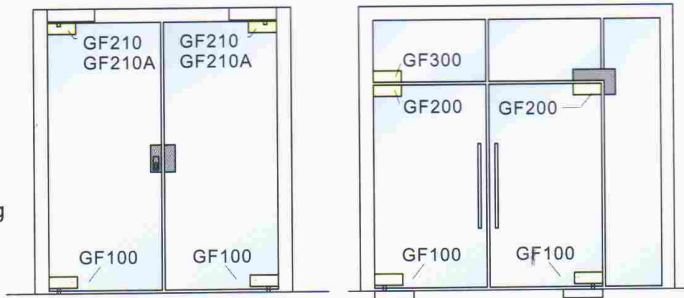

UNIT:mm

GF100

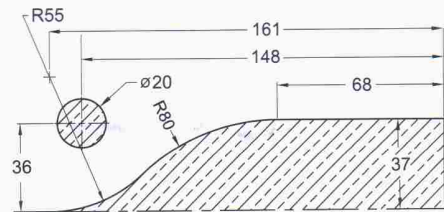
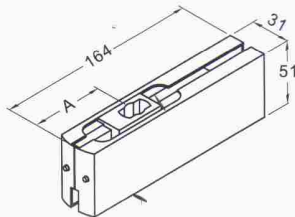

GF200

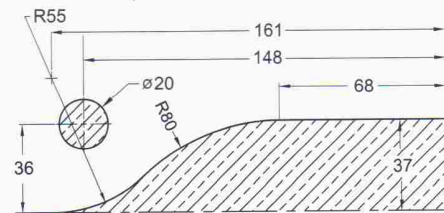
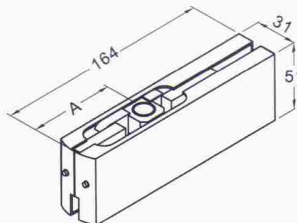

GF210

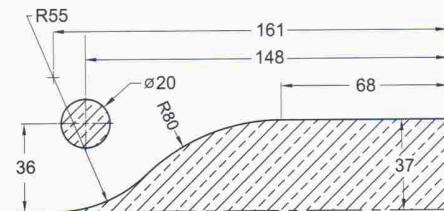
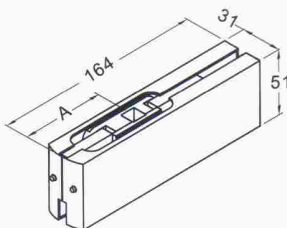

GF210A (adjustable) NEW

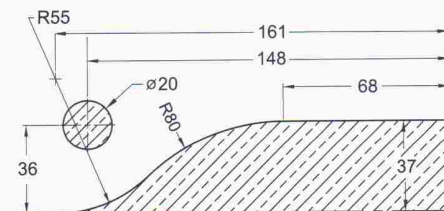
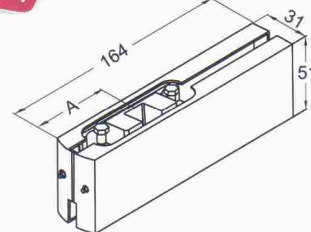

GF300

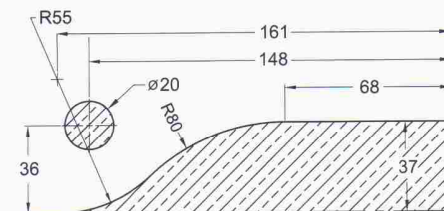
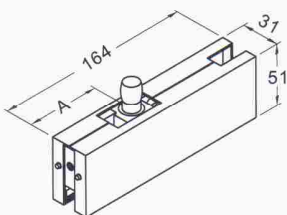
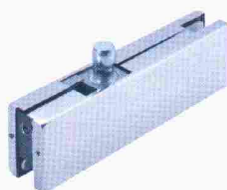

Glass Fitting

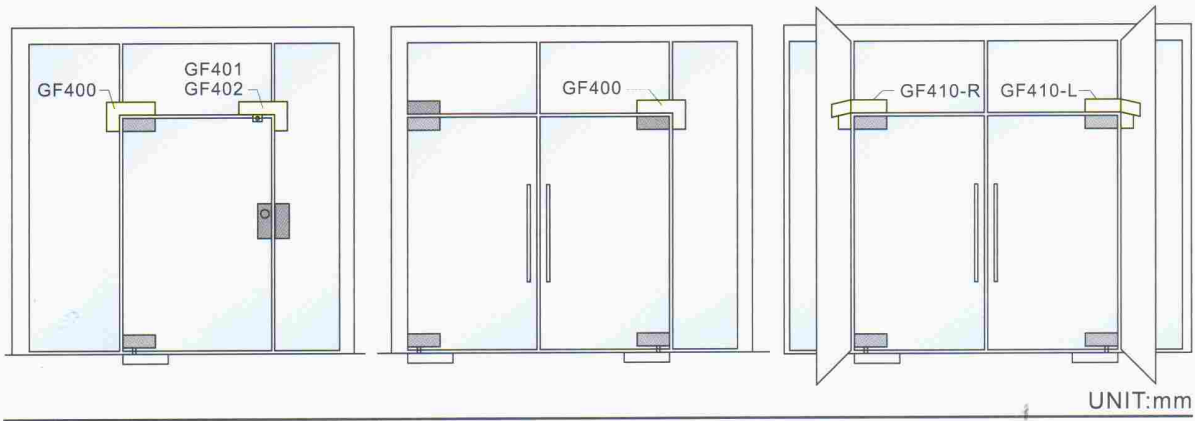

GF400

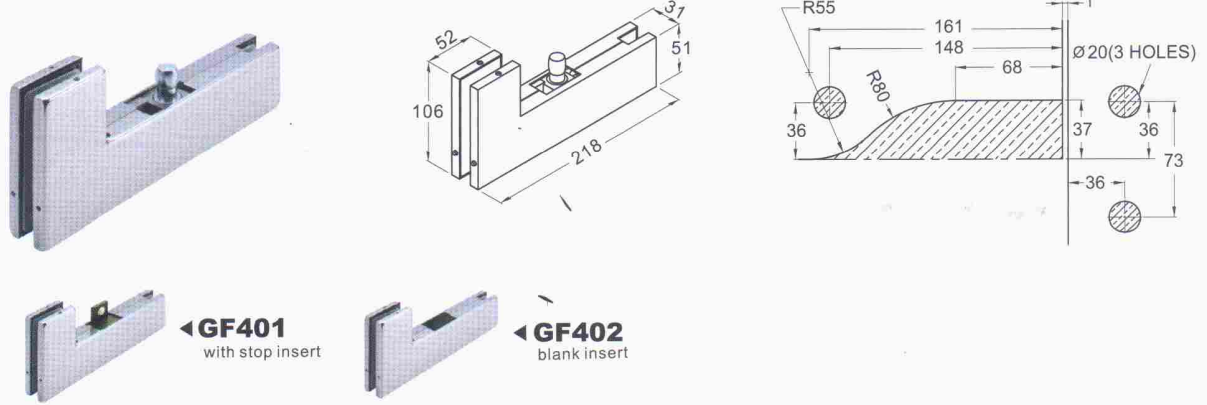

GF410-L

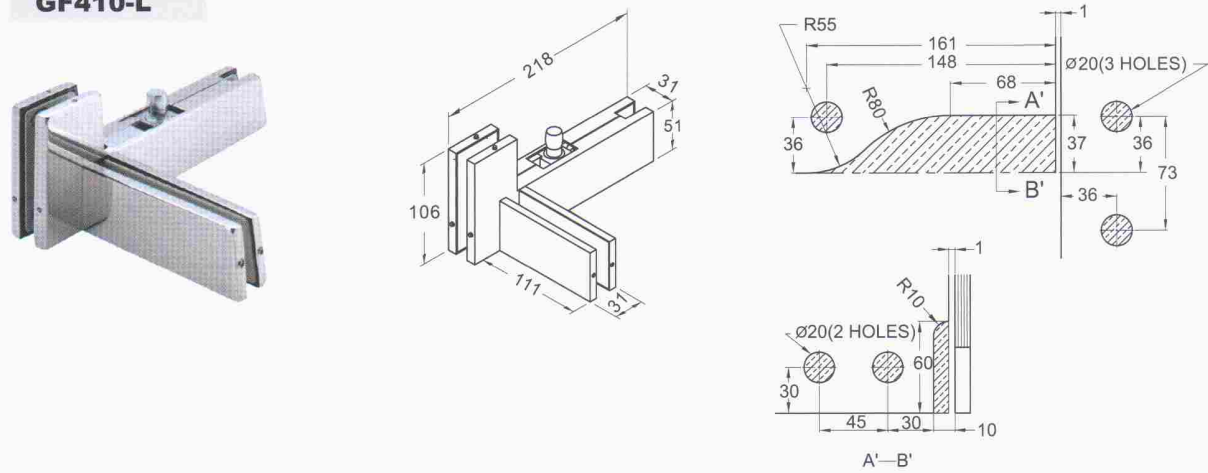

GF410-R

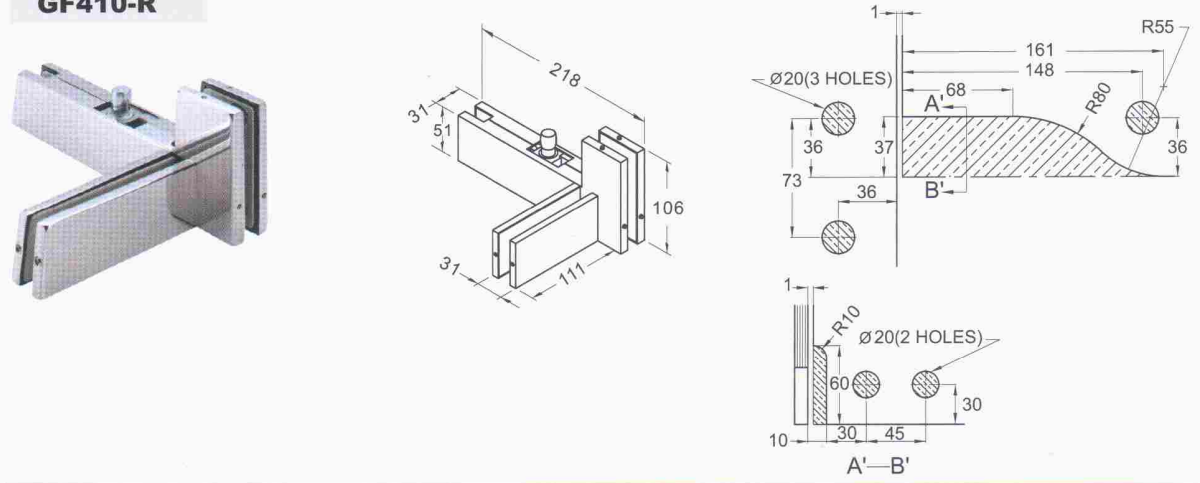

Material	Material No.	Cover Finish
Stainless Steel	SUS304	PSS,BSS,PVD
	SUS316	
Aluminium	1050	AL,CL,DU,DB
Brass	C2680	PB,BSB

Maximum Door Weight: 100kgs(220 lbs)
 Maximum Door Width: 1100mm(43")
 For 10mm(3/8")~12mm(1/2") Glass

- (PSS:Polished Stainless Steel
- (BSS:Brushed Stainless Steel
- (PVD:Polished Zirconium
- (AL:Brushed Aluminium Anodizing
- (CL:Matt Aluminium Anodizing
- (DU:Duranodic Aluminium Anodizing
- (DB:Brushed Duranodic Aluminium Anodizing
- (PB:Polished Brass
- (BSB:Brushed Satin Brass

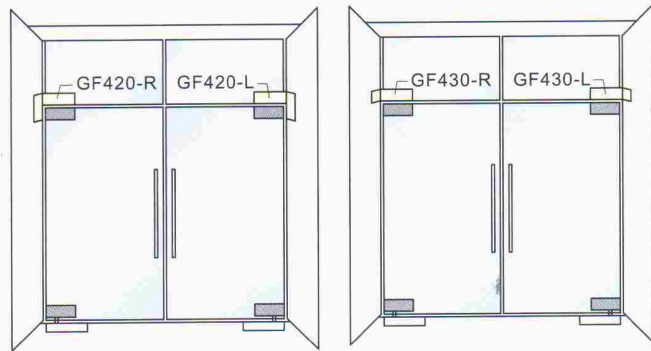

UNIT:mm

GF420-L

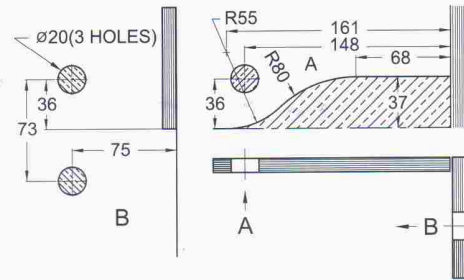
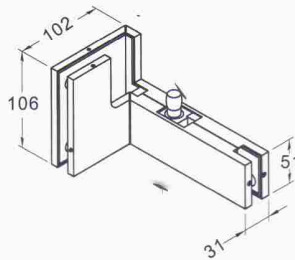
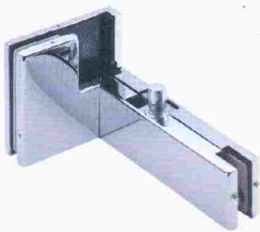

GF420-R

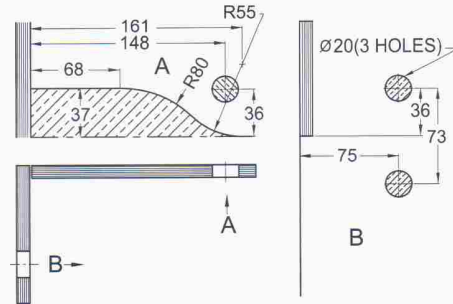
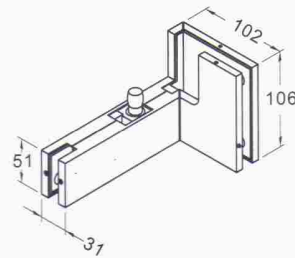

GF430-L

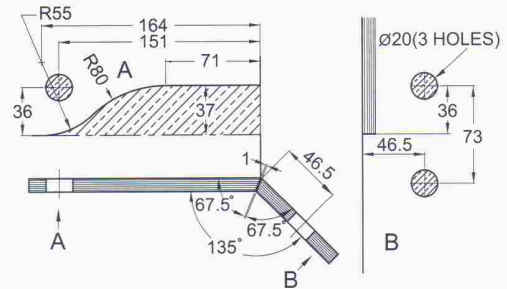
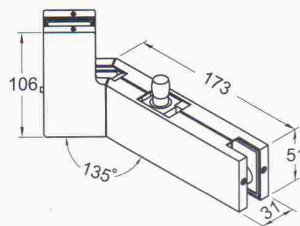

GF430-R

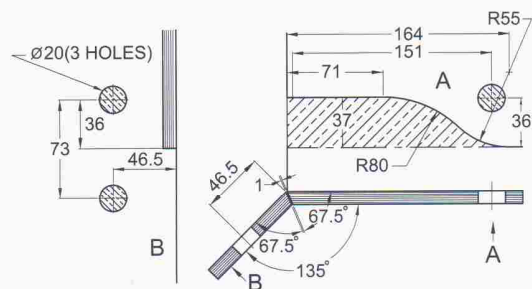
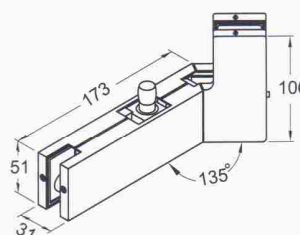

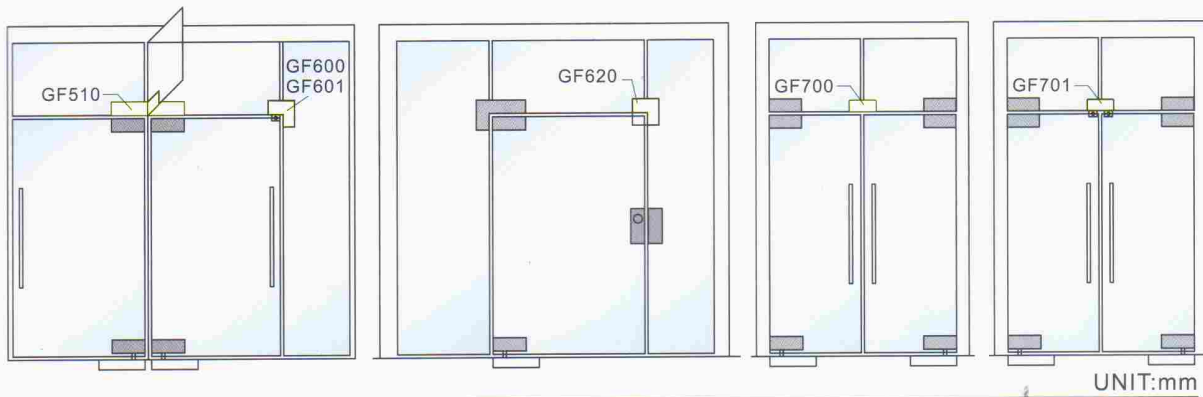

GF510

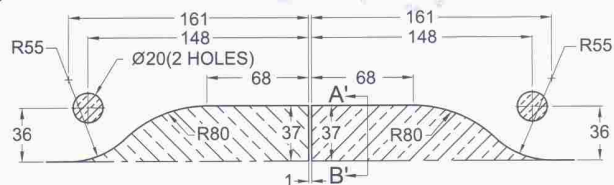
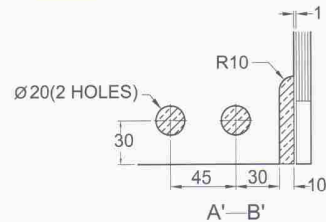
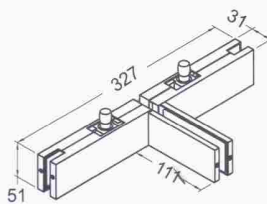

GF600



◀ **GF601**
with stop insert

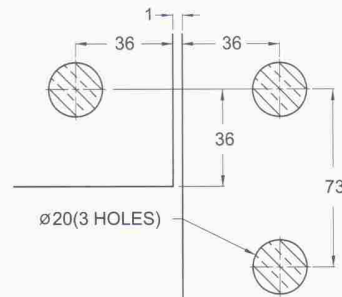
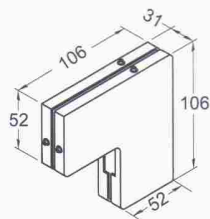

GF620

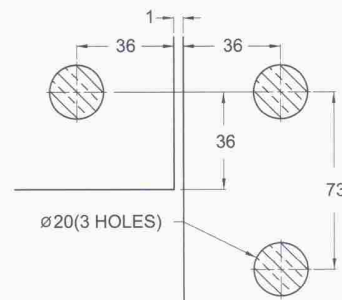
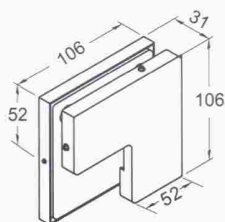
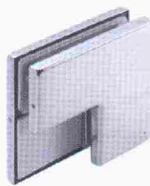

GF700



◀ **GF701**
with stop insert

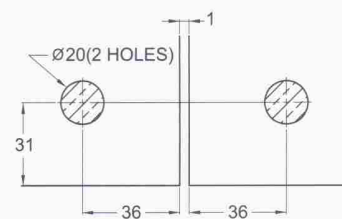
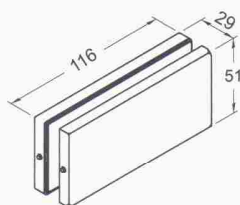

Material	Material No.	Cover Finish
Stainless Steel	SUS304	PSS,BSS,PVD
	SUS316	
Aluminium	1050	AL,CL,DU,DB
Brass	C2680	PB,BSB

Maximum Door Weight: 100kgs(220 lbs)
 Maximum Door Width: 1100mm(43")
 For 10mm(3/8")~12mm(1/ 2") Glass

- (PSS:Polished Stainless Steel
- (BSS:Brushed Stainless Steel
- (PVD:Polished Zirconium
- (AL:Brushed Aluminium Anodizing
- (CL:Matt Aluminium Anodizing
- (DU:Duranodic Aluminium Anodizing
- (DB:Brushed Duranodic Aluminium Anodizing
- (PB:Polished Brass
- (BSB:Brushed Satin Brass

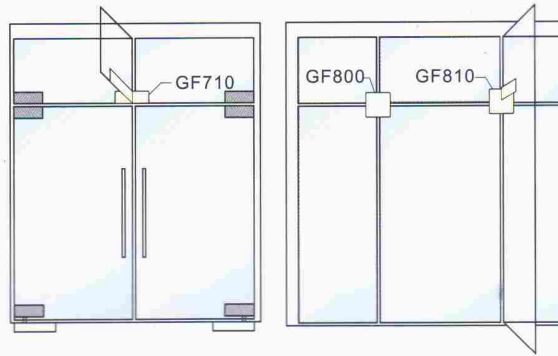

UNIT:mm

GF710

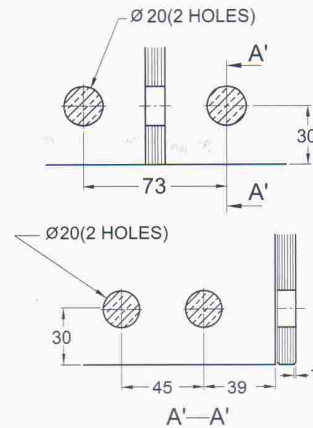
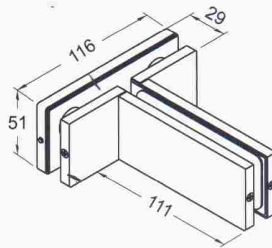
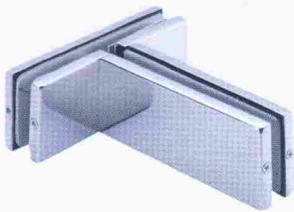

GF800

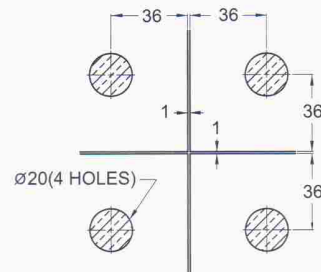
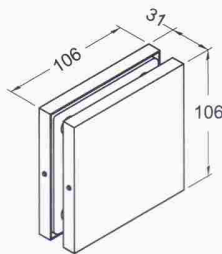

GF810

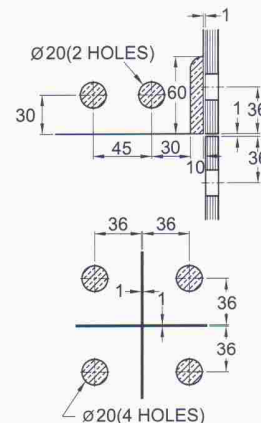
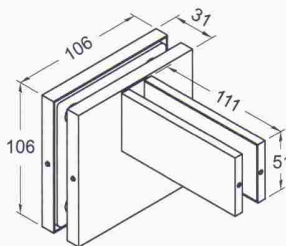
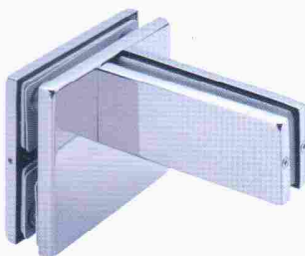

Glass Fitting

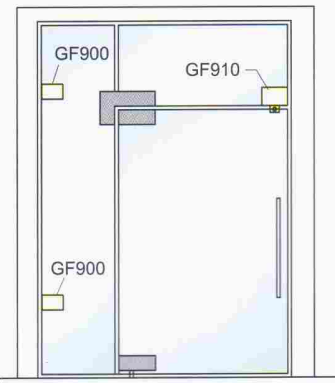

UNIT:mm

GF900 **NEW**

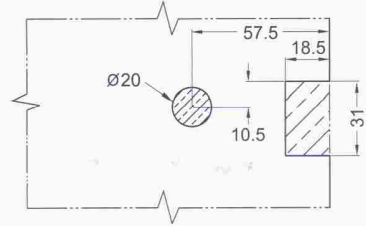
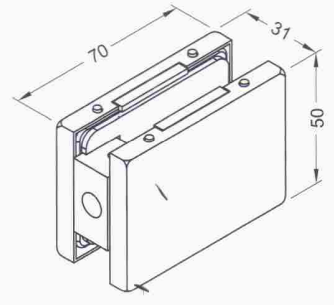

GF910 **NEW**

with stop insert

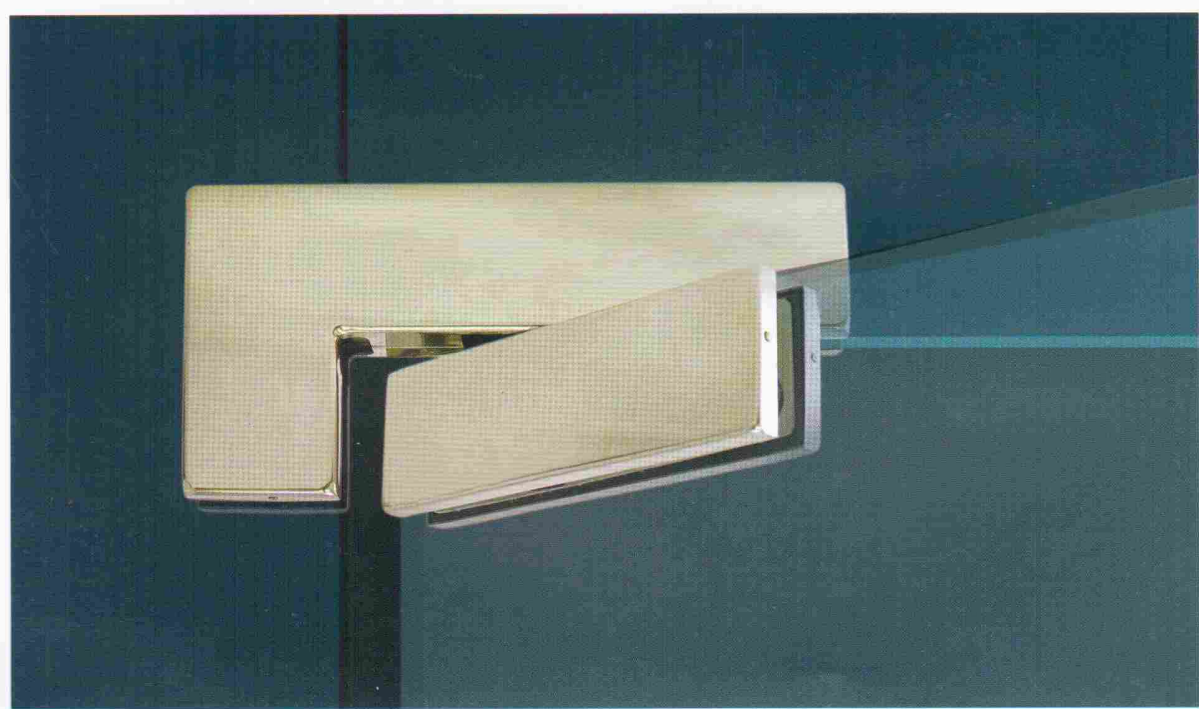
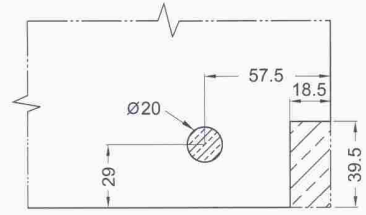
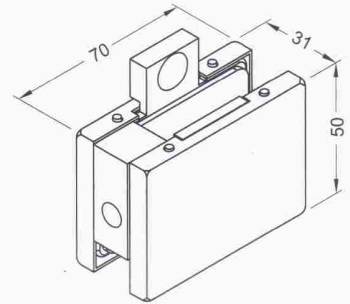

Material	Material No.	Cover Finish
Stainless Steel	SUS304	PSS,BSS,PVD
	SUS316	
Aluminium	1050	AL,CL,DU,DB
Brass	C2680	PB,BSB

For 10mm(3/8")~12mm(1/2") Glass

- { PSS: Polished Stainless Steel
- { BSS: Brushed Stainless Steel
- { PVD: Polished Zirconium
- { AL: Brushed Aluminium Anodizing
- { CL: Matt Aluminium Anodizing
- { DU: Duranodic Aluminium Anodizing
- { DB: Brushed Duranodic Aluminium Anodizing
- { PB: Polished Brass
- { BSB: Brushed Satin Brass

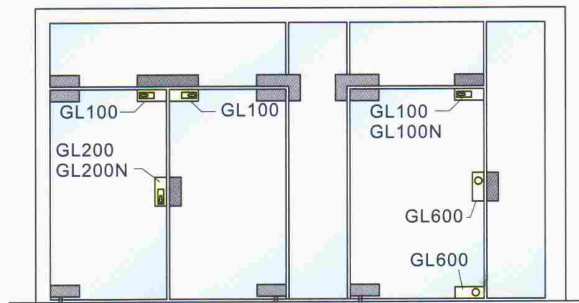

UNIT:mm

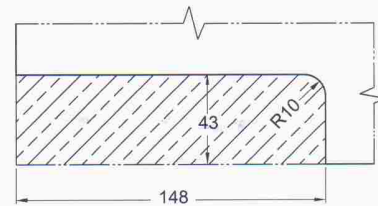
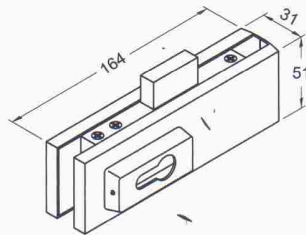
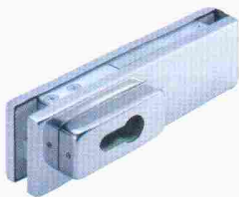
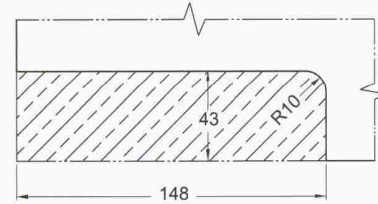
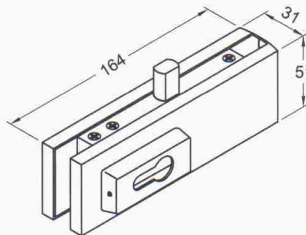
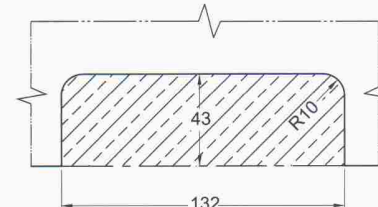
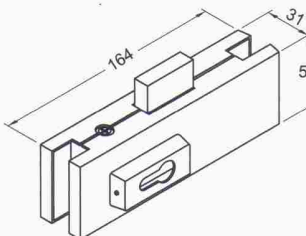
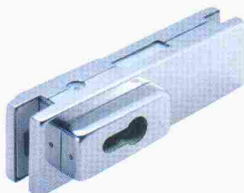
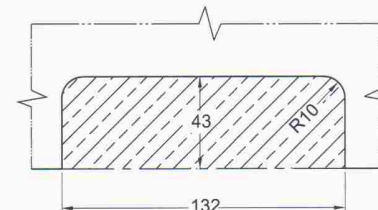
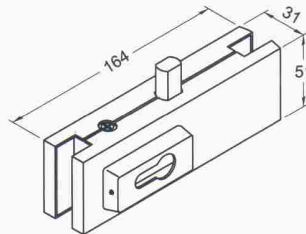
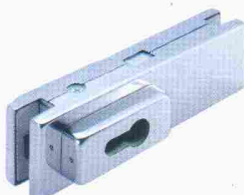
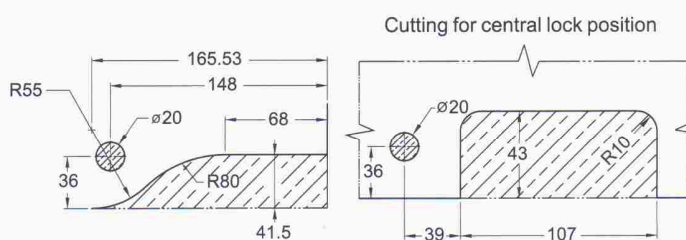
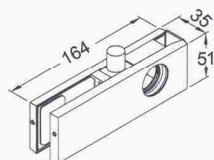
GL100

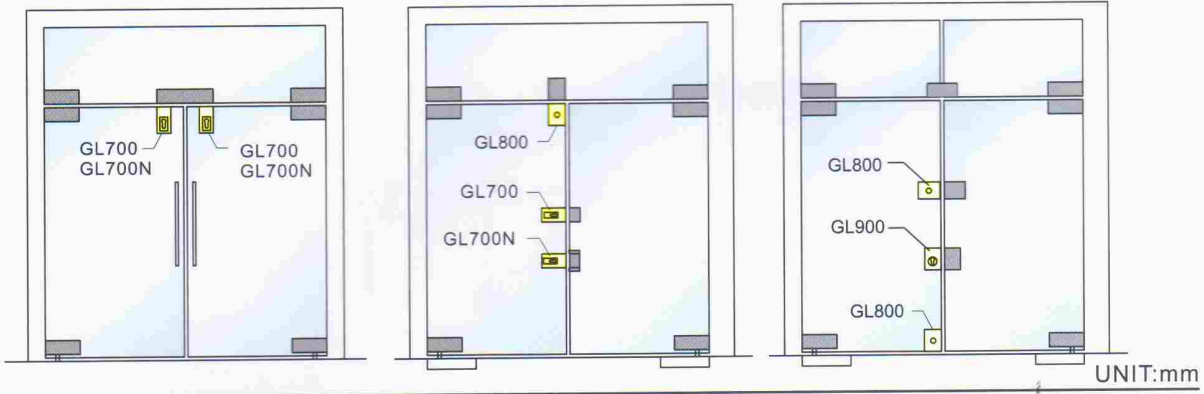
GL100N

GL200

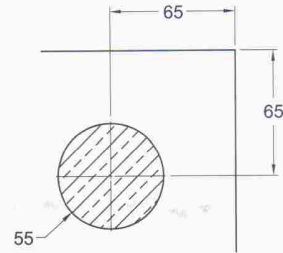
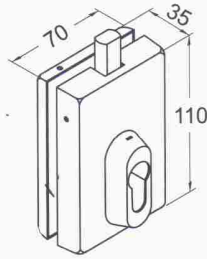
GL200N

GL600



GL700 **GL701**



GL700N **GL701N**

without glass cut-out for 10mm(3/8")~12mm(1/2") glass

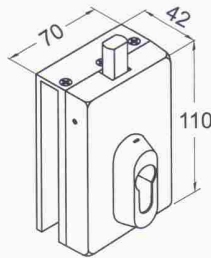

GL800 NEW

For glass 8mm(5/16") ~ 12mm(1/2")

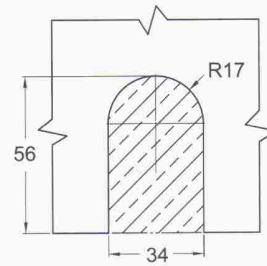
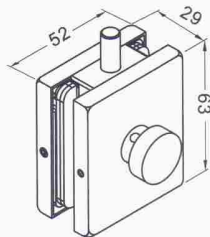

GL900 NEW

For glass 8mm(5/16") ~ 12mm(1/2")

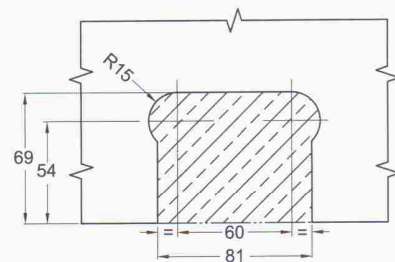
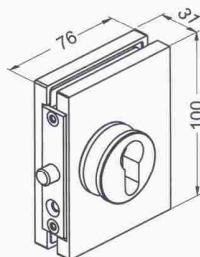

Glass Lock Keeper



GLASS LOC
KEEPER

GK

Material	Material No.	Cover Finish
Stainless Steel	SUS304	PSS,BSS,PVD
	SUS316	
Aluminium	1050	AL,CL,DU,DB
Brass	C2680	PB,BSB

For 10mm(3/8")~12mm(1/2") Glass

- { PSS: Polished Stainless Steel
- { BSS: Brushed Stainless Steel
- { PVD: Polished Zirconium
- { AL: Brushed Aluminium Anodizing
- { CL: Matt Aluminium Anodizing
- { DU: Duranodic Aluminium Anodizing
- { DB: Brushed Duranodic Aluminium Anodizing
- { PB: Polished Brass
- { BSB: Brushed Satin Brass

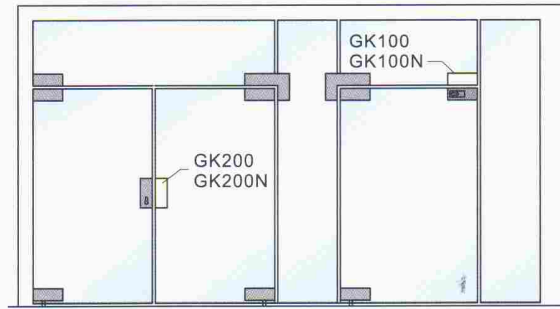

UNIT:mm

GK100

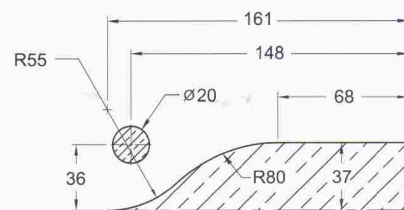
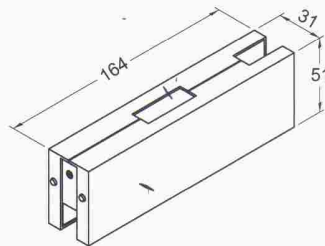
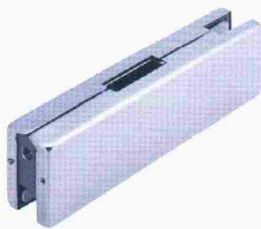

GK100N

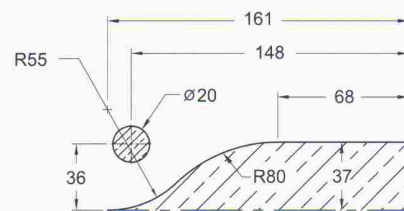
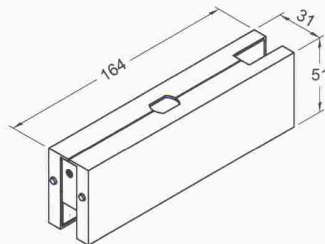
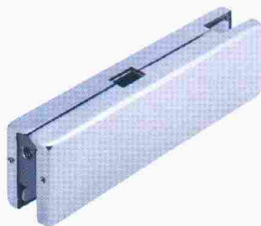

GK200

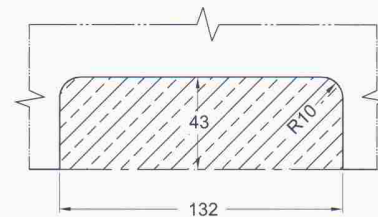
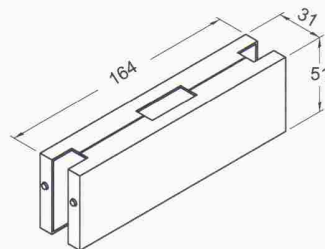

GK200N

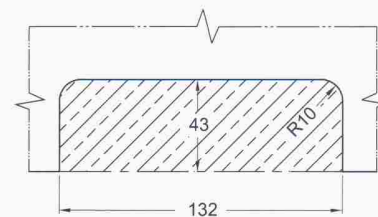
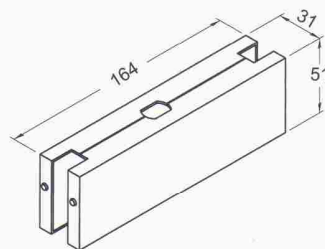
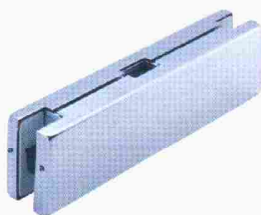

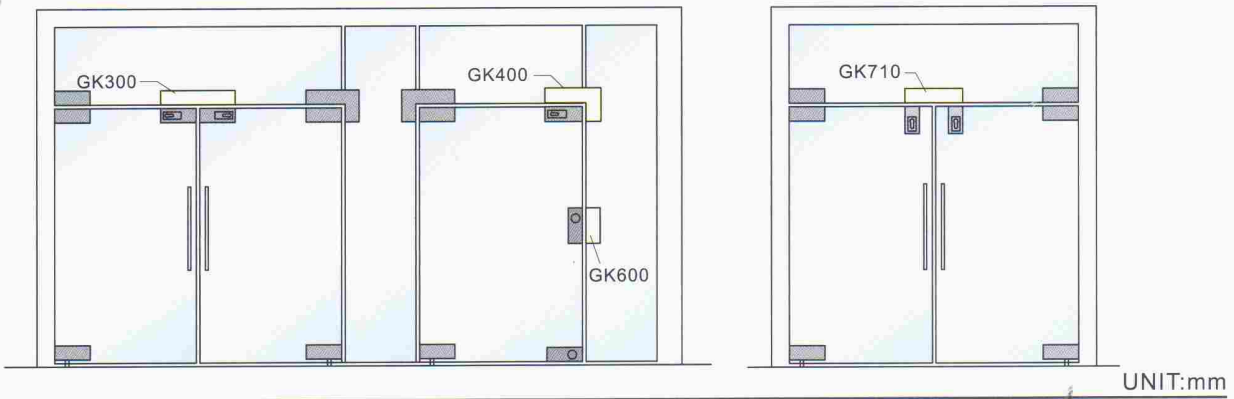

GK300

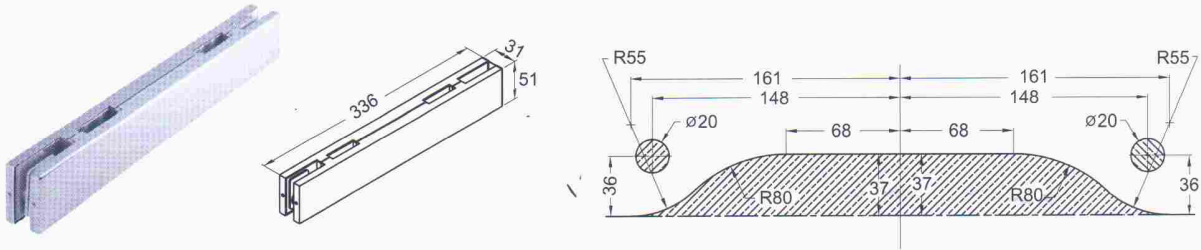

GK400

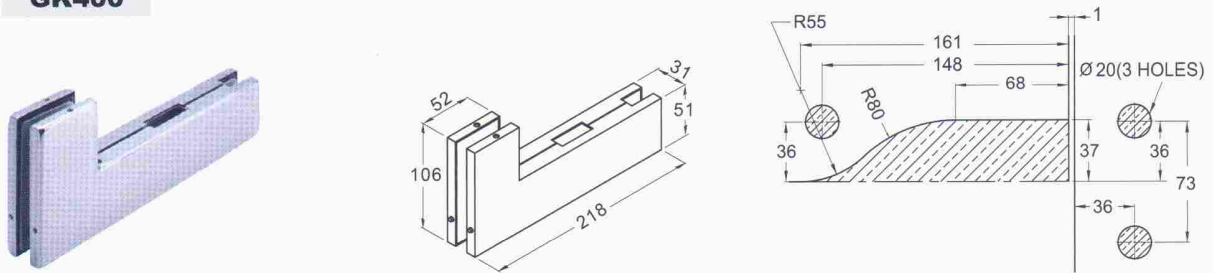

GK600

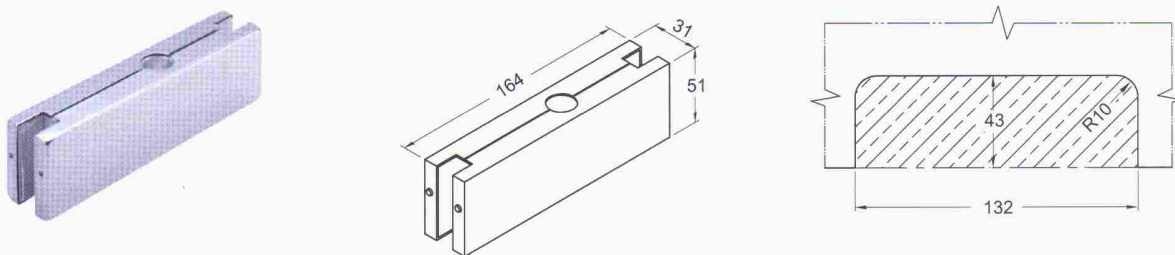

GK710

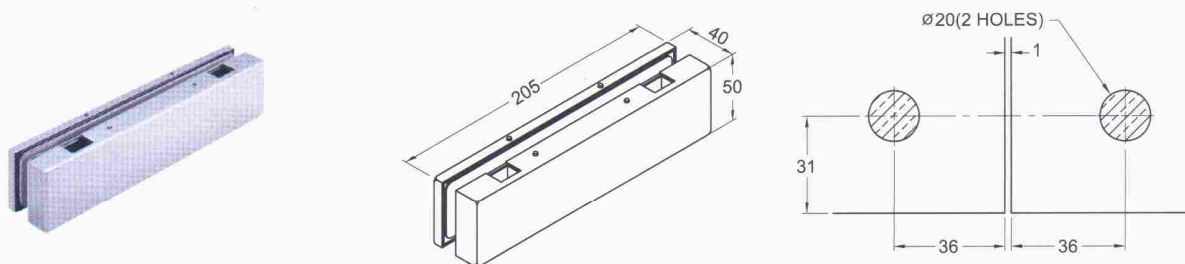

Material	Material No.	Cover Finish
Stainless Steel	SUS304	PSS,BSS,PVD
	SUS316	
Aluminium	1050	AL,CL,DU,DB
Brass	C2680	PB,BSB

For 10mm(3/8")~12mm(1/2") Glass

- { PSS:Polished Stainless Steel
- { BSS:Brushed Stainless Steel
- { PVD:Polished Zirconium
- { AL:Brushed Aluminium Anodizing
- { CL:Matt Aluminium Anodizing
- { DU:Duranodic Aluminium Anodizing
- { DB:Brushed Duranodic Aluminium Anodizing
- { PB:Polished Brass
- { BSB:Brushed Satin Brass

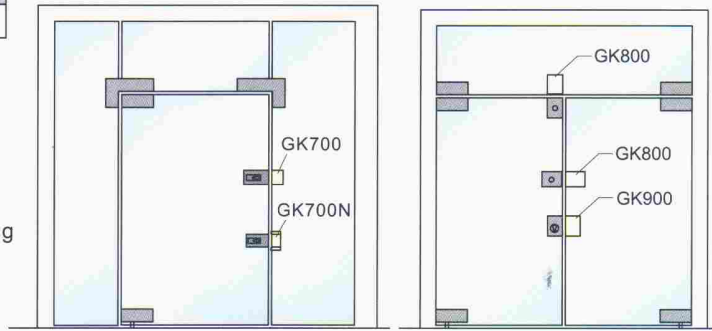

UNIT:mm

GK700

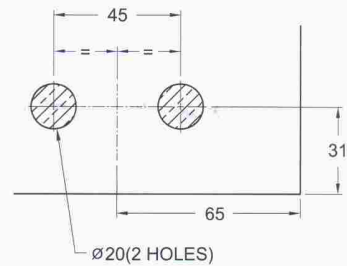
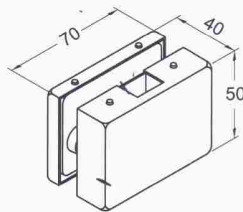

GK700N

without glass cut-out for 10mm(3/8")~12mm(1/2") glass

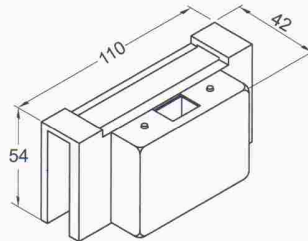
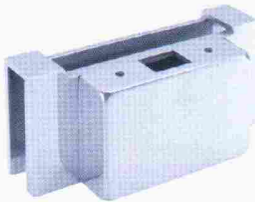

GK800

NEW

For glass 8mm(5/16") ~ 12mm(1/2")

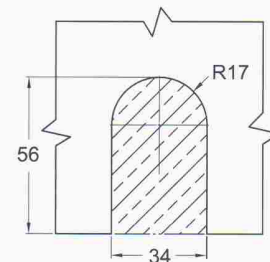
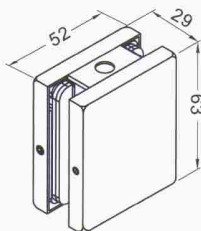

GK900

NEW

For glass 8mm(5/16") ~ 12mm(1/2")

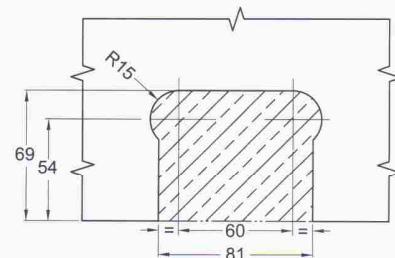
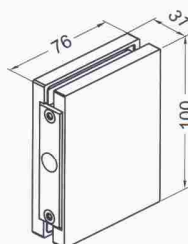

INSERT-D

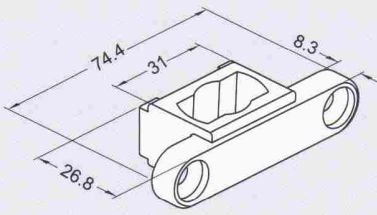

INSERT-M

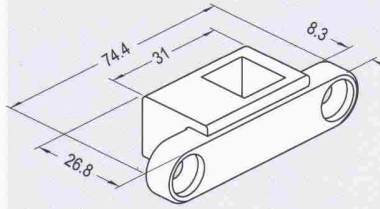

INSERT-C

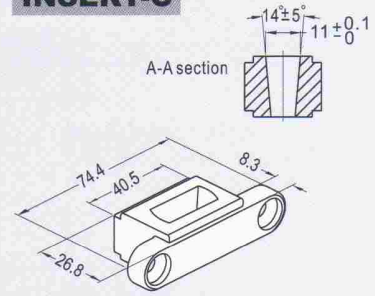

INSERT-N

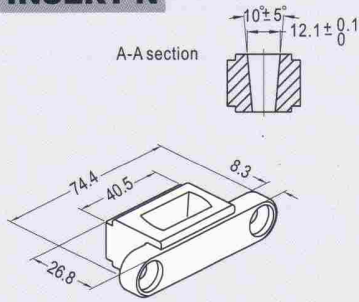

8805

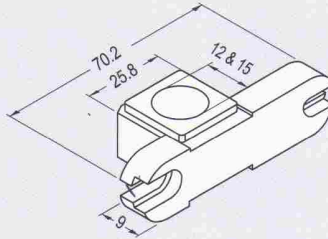

8806

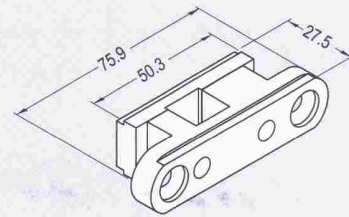

8809

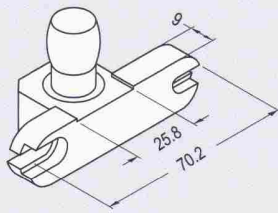

8814

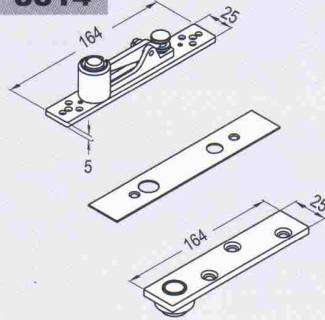

8815

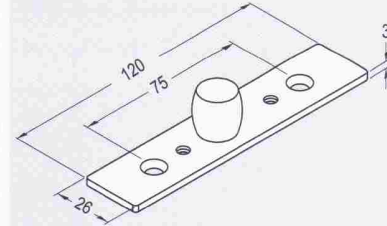

8816

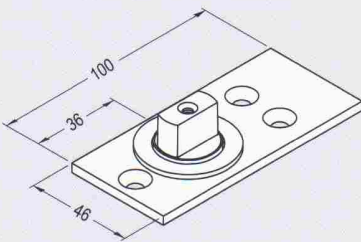

8817

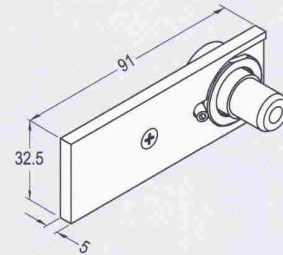

8819

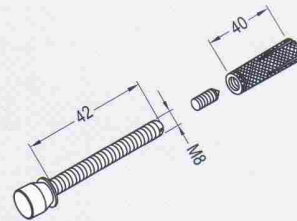

8820

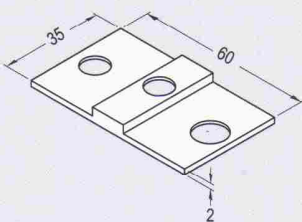

8821

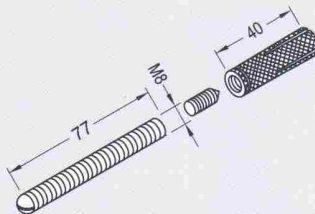

8823

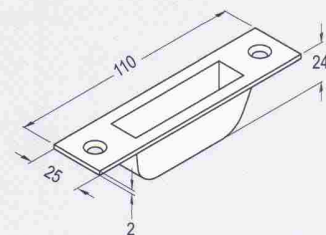

Material	Material No.	Cover Finish
Stainless Steel	SUS316	BSS or Raw finish

BSS:Brushed Stainless Steel

Maximum Door Weight: 80kgs(176 lbs)
 Maximum Door Width: 1200mm(47")
 Maximum Door Height: 2500mm(98")
 For 10mm(3/8")~12mm(1/2") Glass

UNIT:mm

Specification & Glass Cut-Out

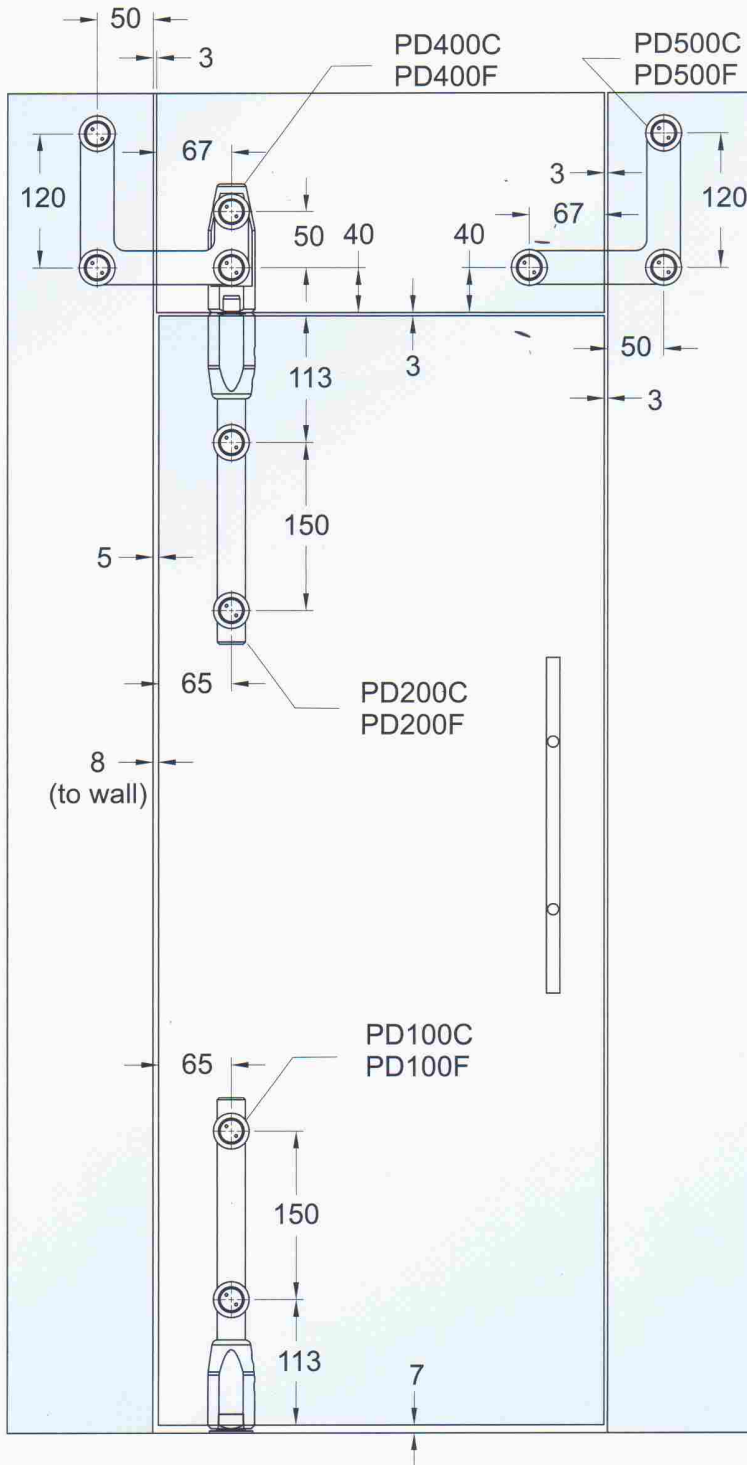

Countersink Type Glass Cut-Out

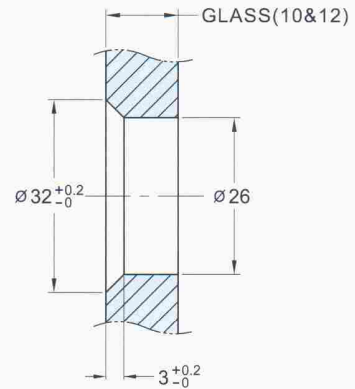

Flat Type Glass Cut-Out

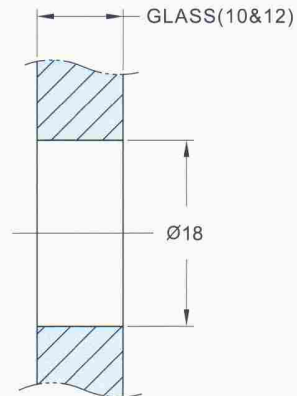

Pivot Door (Countersink Type)



UNIT:mm

PD100C

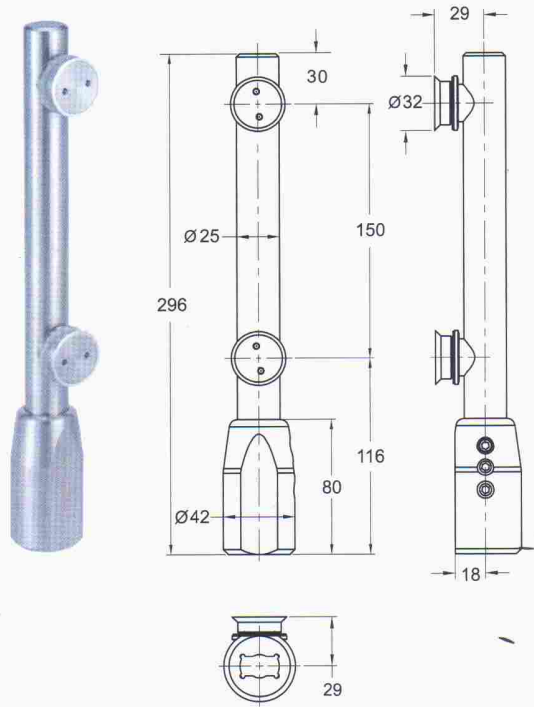

PD200C

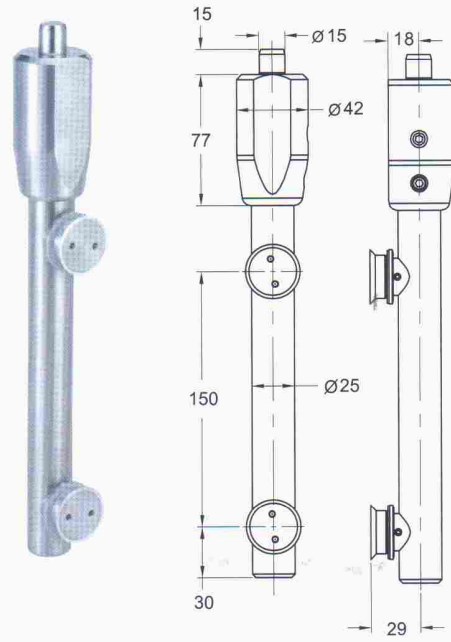

PD300C

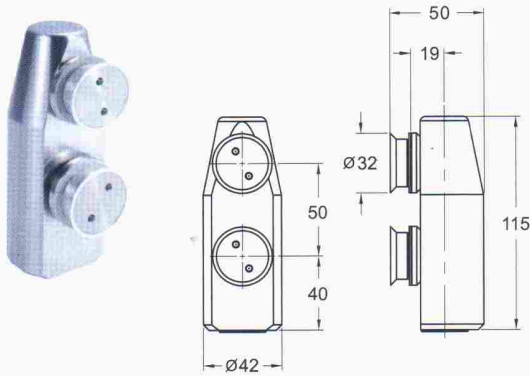

PD400C

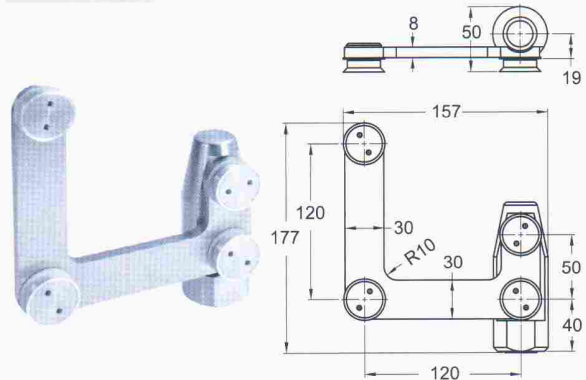

PD500C

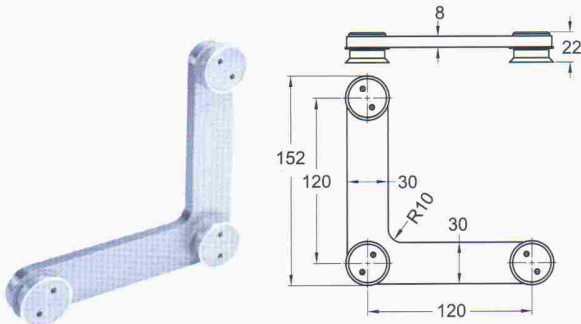

PD700

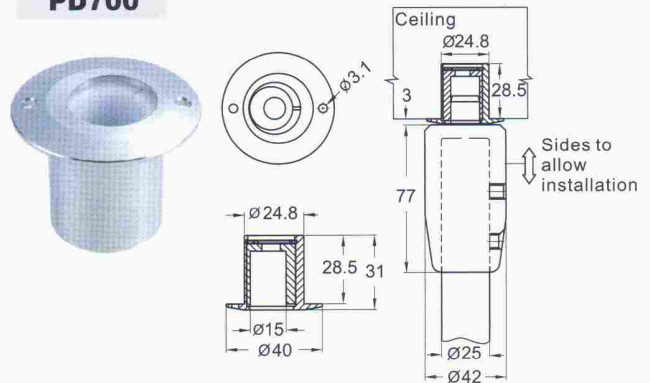

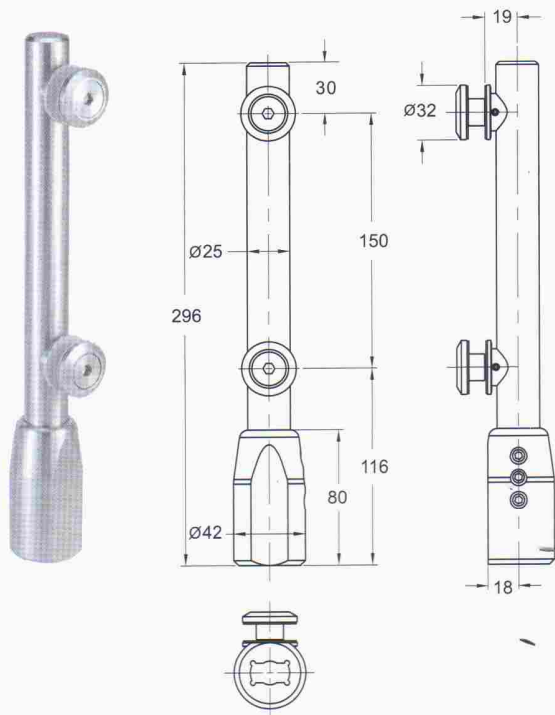
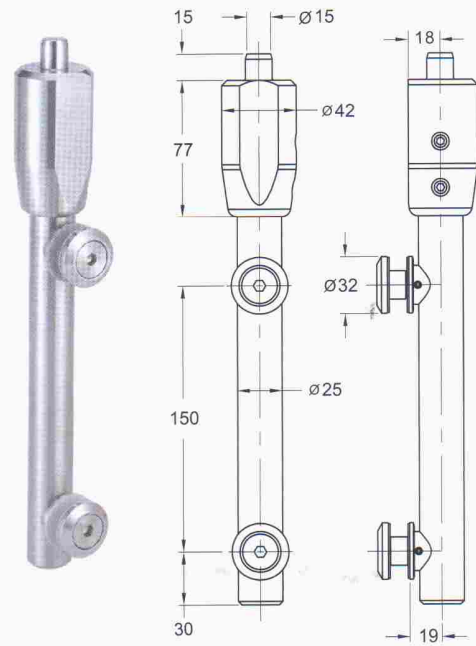
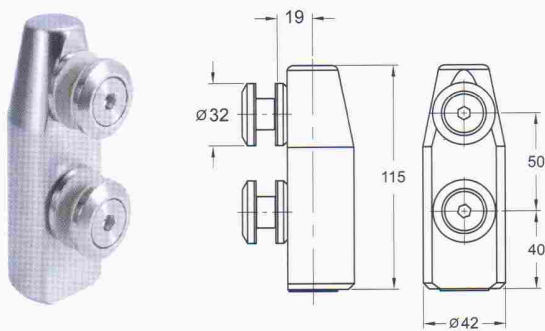
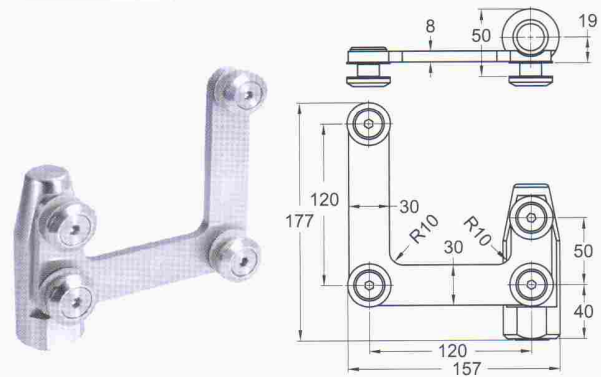
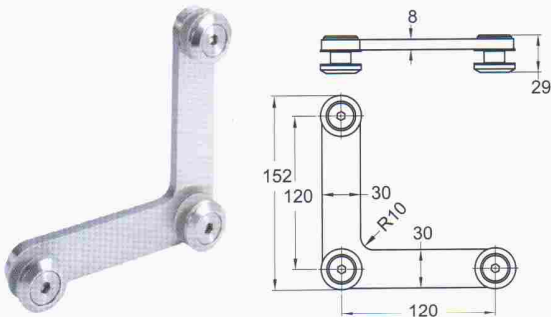
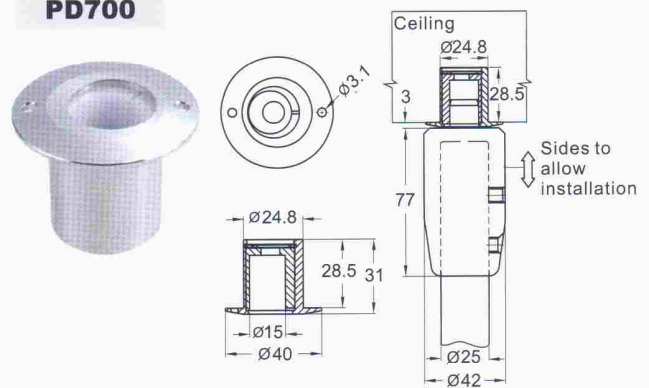
PD100F

PD200F

PD300F

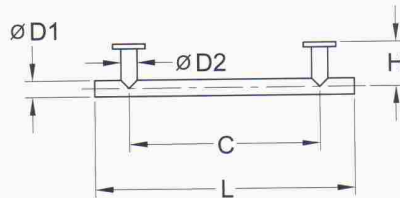
PD400F

PD500F

PD700

 PIVOT DOOR
PD

UNIT:mm

PH102 Material: SUS304 Finish: PSS/BSS/PVD



Item No.	Ø D1	Ø D2	L	C	H
PH102A	Ø 22	Ø 19	800	600	60
PH102B	Ø 25	Ø 22	1000	800	60
PH102C	Ø 32	Ø 25	1200	1000	65
PH102D	Ø 38	Ø 32	1500	1200	70
PH102E	Ø 25	Ø 22	400	210	60
PH102F	Ø 25	Ø 22	350	250	60
PH102G	Ø 25	Ø 22	720	620	60
PH102H	Ø 25	Ø 22	1760	520x3	60
PH102I	Ø 25	Ø 22	400	250	60
PH102J	Ø 25	Ø 22	800	400	60
PH102K	Ø 25	Ø 22	500	350	60
PH102L	Ø 32	Ø 25	1760	680x2	65
PH102M	Ø 32	Ø 25	1000	600	60
PH102N	Ø 25	Ø 22	300	150	60
PH102O	Ø 25	Ø 22	450	300	60
PH102P	Ø 25	Ø 22	600	400	60
PH102Q	Ø 25	Ø 22	1400	1240	60
PH102R	Ø 25	Ø 22	900	720	60

PH103 Material: SU304 Finish: PSS/BSS/PVD

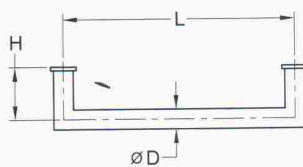
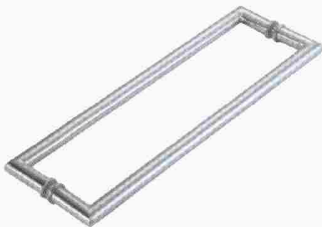

Item No.	Ø D	L	H
PH103A	Ø 25	250	57.5
PH103B	Ø 25	300	57.5
PH103C	Ø 25	350	57.5
PH103D	Ø 32	350	59

PH104 Material: SUS304 Finish: PSS+BSS

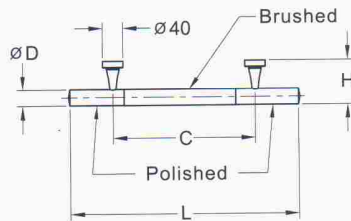

Item No.	ØD	L	C	H
PH104A	Ø 32	1200	1000	56
PH104B	Ø 25	1500	1200	52.5
PH104C	Ø 38	2000	1600	59
PH104D	Ø 25	400	210	52.5

PH117 Material: SUS304 Finish: PSS , BSS , PVD

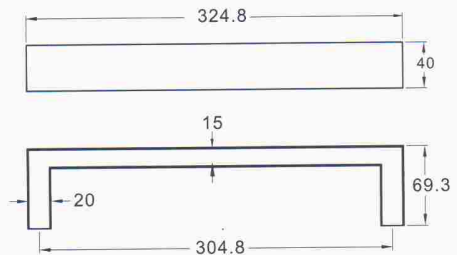
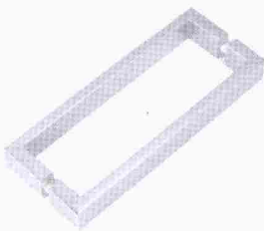

PH200 Material: SUS304 Finish: PSS , BSS , PVD

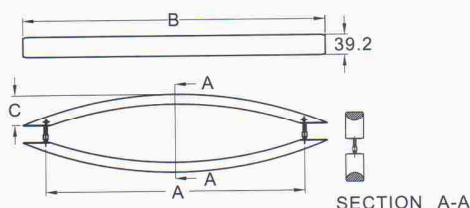

Item No.	A	B	C
PH200	450	537	49
PH201	500	587	59
PH202	750	837	77
PH203	750	837	125

Material	Material No.	Finish
Aluminium	AL6063	AL
Brass	C3771	PC,AN,PVD,PSC

Maximum Door Weight : 45kgs(99 lbs)
 Maximum Door Width : 1000mm(39")
 For 8mm(5/16")~10mm(3/8") Glass

AL:Brushed Aluminium Anodizing

- PC:Polished Chrome
- AN:Antique Nickel
- PVD:Polished Zirconium
- PSC:Polished Satin Chrome

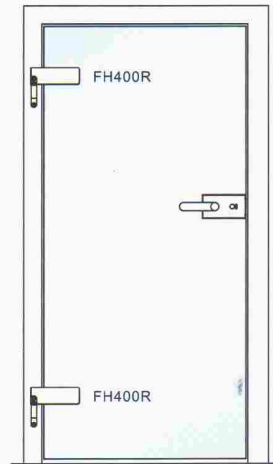

UNIT:mm

FH400C

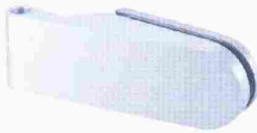

FH400CN NEW



FH400R NEW



FH400RN NEW

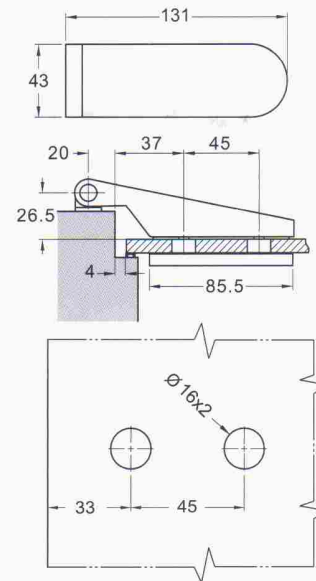

© Material:Aluminium

FH400C NEW



FH400F PATENT RIGHT



FH400G



FH400N



FH400R NEW

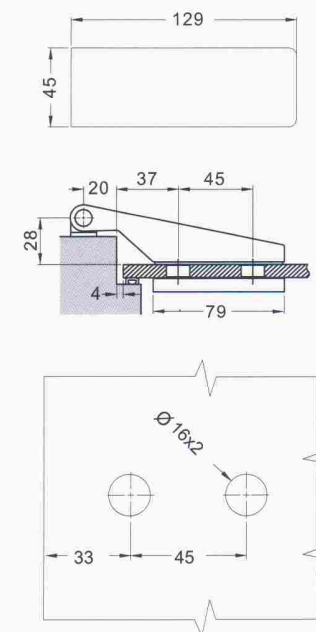

© Material:Brass

Material	Material No.	Finish
Brass	C3771	PC,AN,PVD,PSC

Maximum Door Weight : 45kgs(99 lbs)
 Maximum Door Width : 1000mm(39")
 For 8mm(5/16")~10mm(3/8") Glass

- PC: Polished Chrome
- AN: Antique Nickel
- PVD: Polished Zirconium
- PSC: Polished Satin Chrome

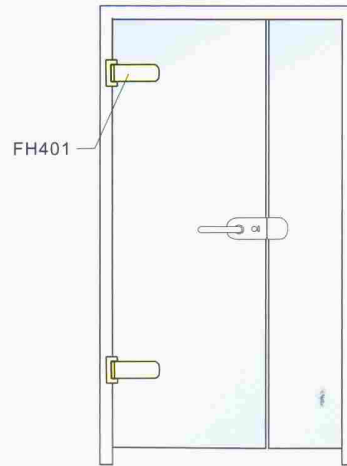

UNIT:mm

FH401C



FH401F PATENT RIGHT

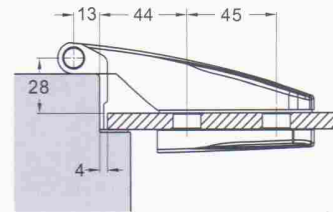
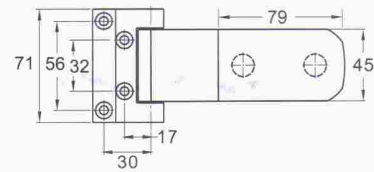

FH401G



FH401N

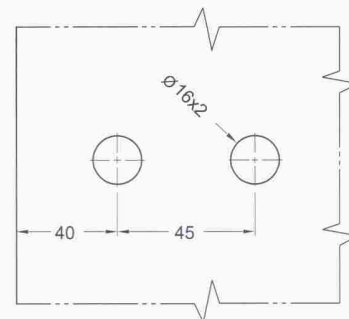

FH401R

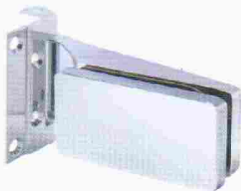

PATCH LOCK
PL

Material	Material No.	Finish
Aluminium	AL6063	AL
Brass	C3771	PC,AN,PVD,PSC

Maximum Door Weight : 45kgs(99 lbs)
 Maximum Door Width : 1000mm(39")
 For 8mm(5/16")~10mm(3/8") Glass

- AL:Brushed Aluminium Anodizing
- PC:Polished Chrome
- AN:Antique Nickel
- PVD:Polished Zirconium
- PSC:Polished Satin Chrome

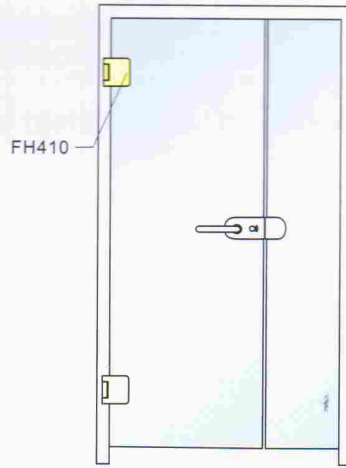

UNIT:mm

FH410R

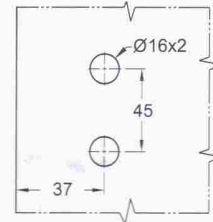
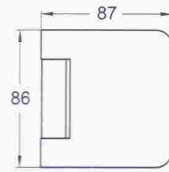

FH410S

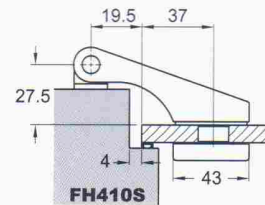
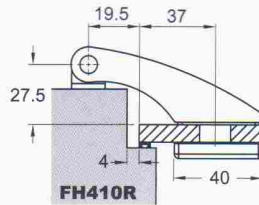

© Material:Aluminium

FH410C

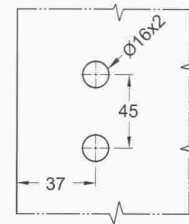
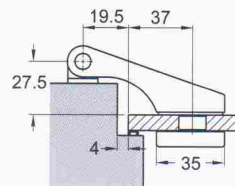
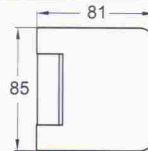

FH410G

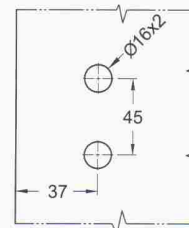
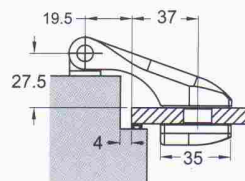
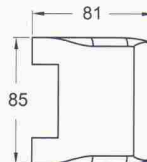

© Material:Brass

Material	Material No.	Finish
Brass	C3771	PC,AN,PVD,PSC

Maximum Door Weight : 45kgs(99 lbs)
 Maximum Door Width : 1000mm(39")
 For 8mm(5/16")~10mm(3/8") Glass

PC: Polished Chrome
 AN: Antique Nickel
 PVD: Polished Zirconium
 PSC: Polished Satin Chrome

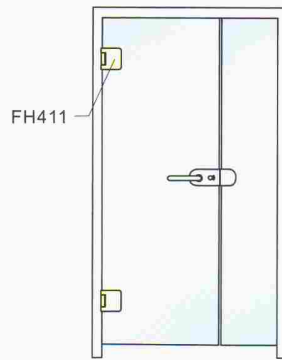

UNIT:mm

FH411C

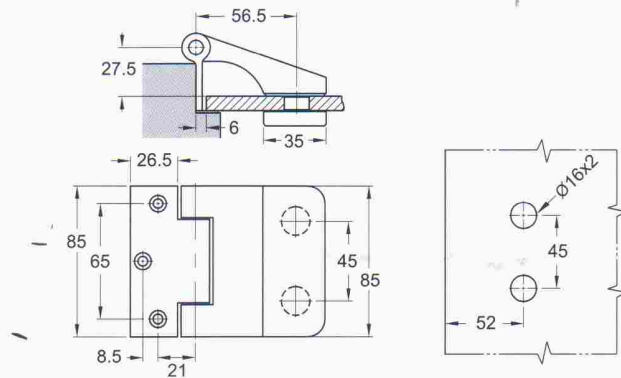
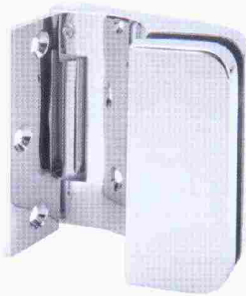

FH411G NEW

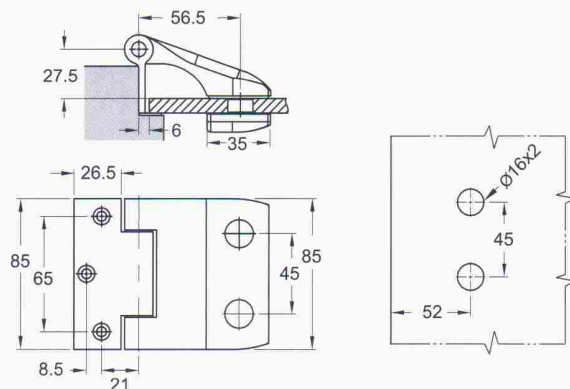

Fixing System of FH400/410 Series

4001

for FH400 series

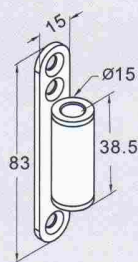

4002

for FH400 series

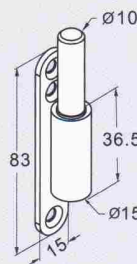

4003

for FH400 series

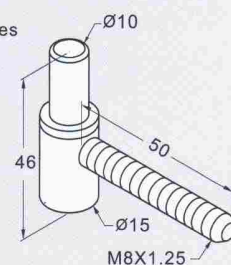

4004

for FH400 series

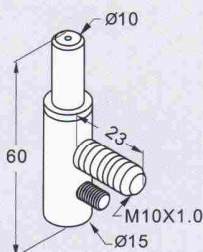

4005

for FH400 series

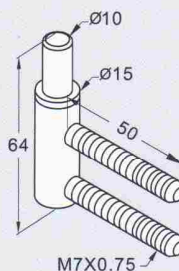

4006

for FH410 series

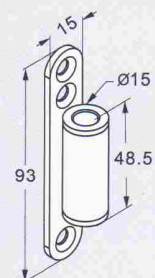

Material	Material No.	Cover Finish
Stainless Steel	SUS304	PSS,BSS,PVD
	SUS316	
Aluminium	1050	AL,CL,DU,DB
Brass	C2680	PB,BSB

For 8mm(5/16")~12mm(1/2") Glass

- { PSS: Polished Stainless Steel
- { BSS: Brushed Stainless Steel
- { PVD: Polished Zirconium
- { AL: Brushed Aluminium Anodizing
- { GD: Golden Yellow
- { DU: Duranodic Aluminium Anodizing
- { DB: Brushed Duranodic Aluminium Anodizing
- { PB: Polished Brass
- { BSB: Brushed Satin Brass

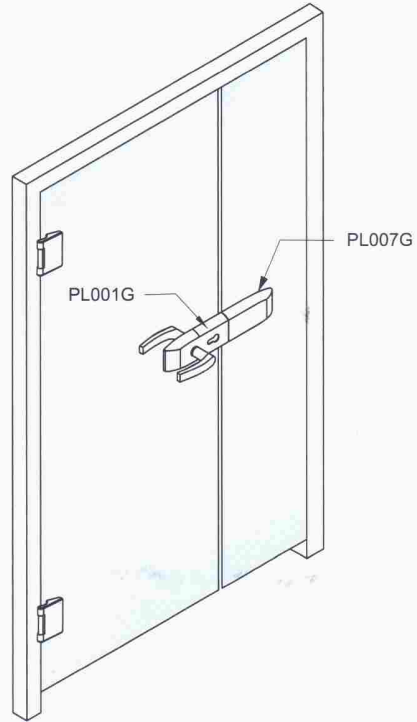
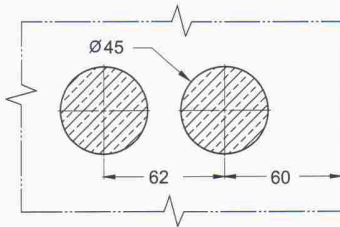

UNIT:mm

■ G Type (Length 175)



UNIT:mm

PL001G/PL001G(BB KEY)
/PL003G/PL005G/PL007G

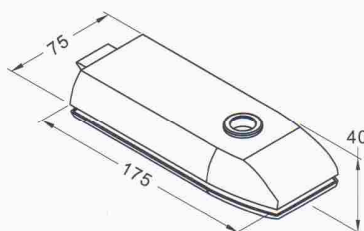

PL002G/PL002G(BB KEY)
/PL004G/PL006G

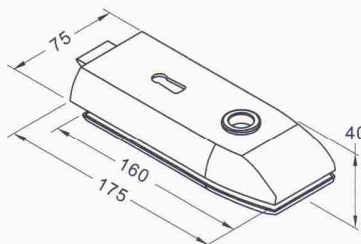

PL008G

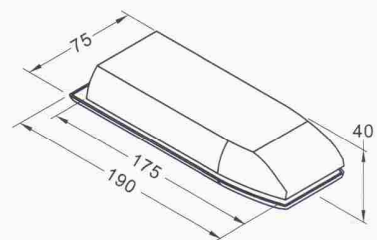

■ R Type (Length 160) NEW



UNIT:mm

PL001R/PL001R(BB KEY)
/PL003R/PL005R/PL007R

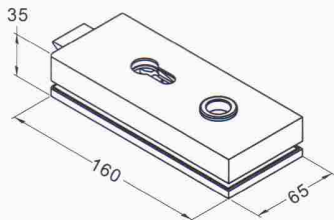

PL002R/PL002R(BB KEY)
/PL004R/PL006R

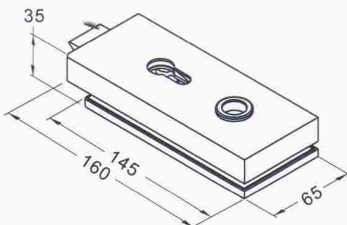

PL008R

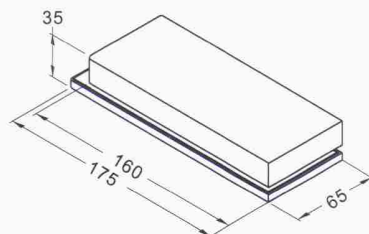

■ S Type (Length 160)

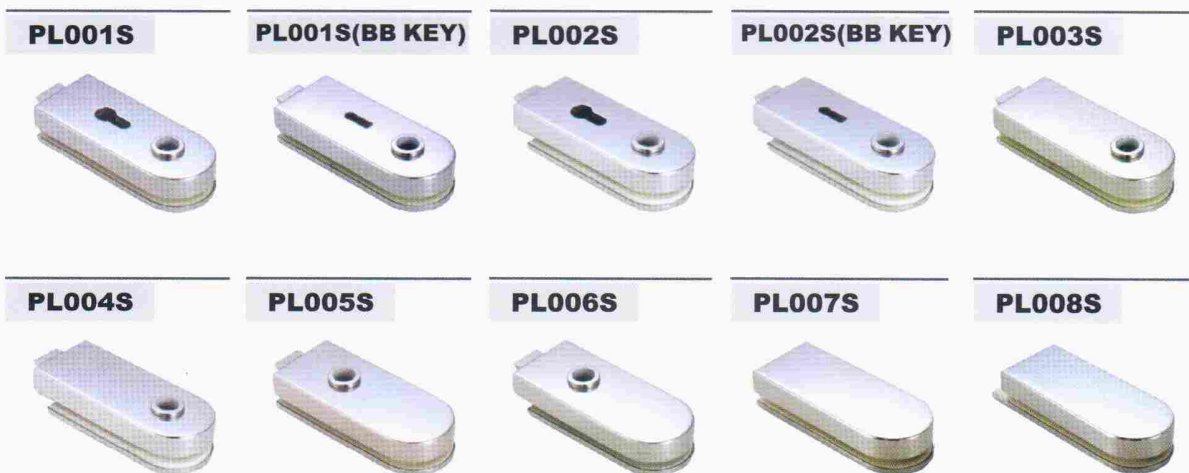

UNIT:mm

PL001S/PL001S(BB KEY)
/PL003S/PL005S/PL007S

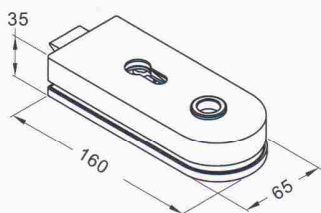

PL002S/PL002S(BB KEY)
/PL004S/PL006S

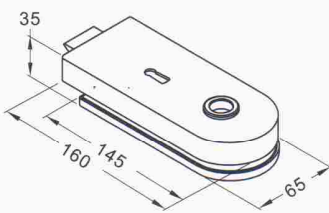

PL008S

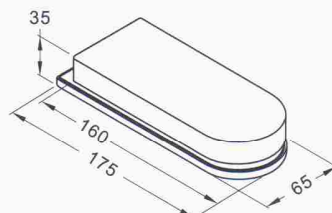

Washroom Lock Without Cylinder



Material	Material No.	Cover Finish
Stainless Steel	SUS304	PSS,BSS,PVD
	SUS316	
Aluminium	1050	AL,CL,DU,DB
Brass	C2680	PB,BSB

{ PSS:Polished Stainless Steel
 BSS:Brushed Stainless Steel
 PVD:Polished Zirconium

{ AL:Brushed Aluminium Anodizing
 GD:Golden Yellow
 DU:Duranodic Aluminium Anodizing
 DB:Brushed Duranodic Aluminium Anodizing

{ PB:Polished Brass
 BSB:Brushed Satin Brass

For 8mm(5/16")~12mm(1/2") Glass

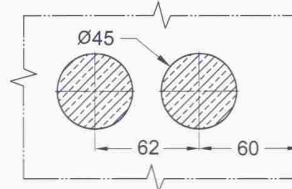
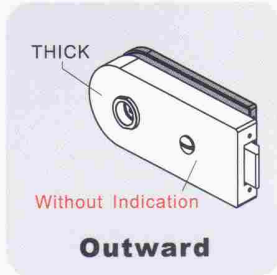
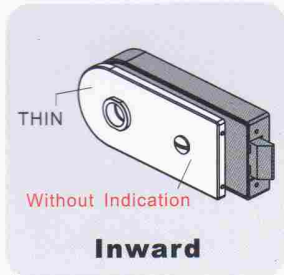

UNIT:mm

■ G Type (Length 175) NEW

PATENT RIGHT

WL001G Inward

WL001G-O Outward

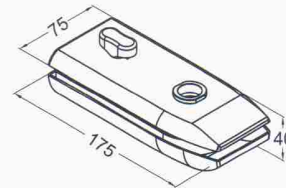
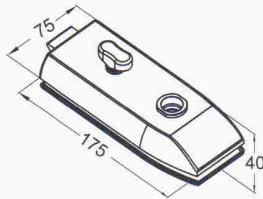

WL002G Inward

WL002G-O Outward

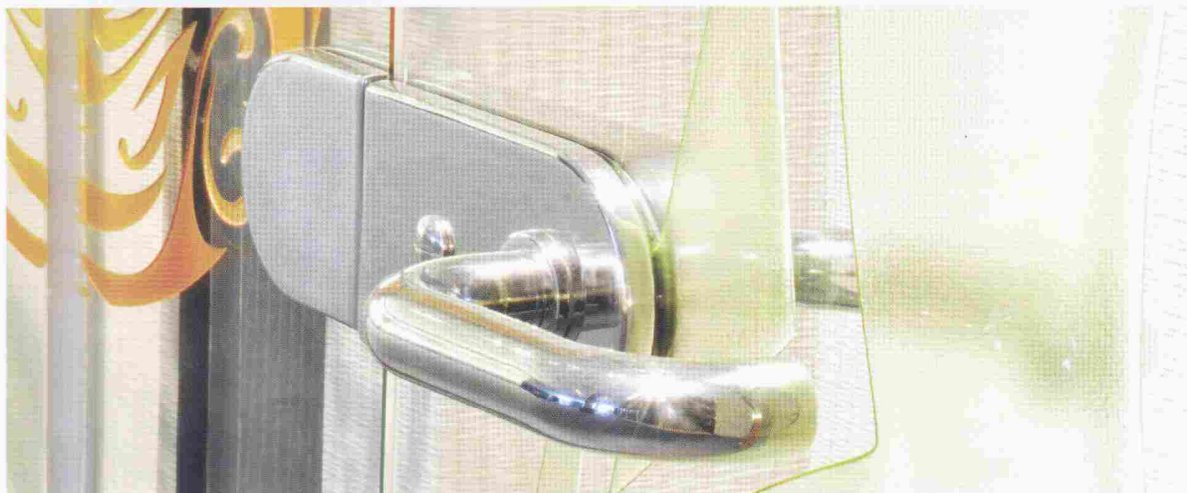
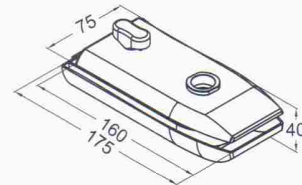
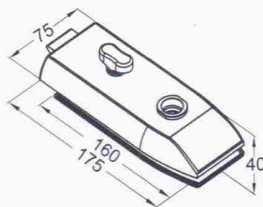

WASHROOM LOCK WITHOUT CYLINDER

WL

Material	Material No.	Cover Finish
Stainless Steel	SUS304	PSS,BSS,PVD
	SUS316	
Aluminium	1050	AL,CL,DU,DB
Brass	C2680	PB,BSB

- { PSS:Polished Stainless Steel
- { BSS:Brushed Stainless Steel
- { PVD:Polished Zirconium
- { AL:Brushed Aluminium Anodizing
- { GD:Golden Yellow
- { DU:Duranodic Aluminium Anodizing
- { DB:Brushed Duranodic Aluminium Anodizing
- { PB:Polished Brass
- { BSB:Brushed Satin Brass

For 8mm(5/16")~12mm(1/2") Glass

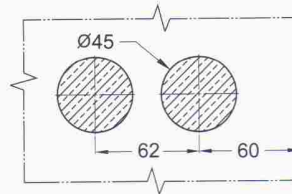
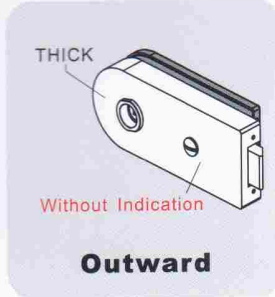
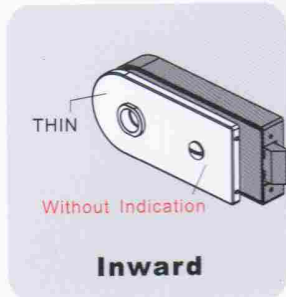

UNIT:mm

■ R Type(Length 160) NEW

PATENT RIGHT



WL001R Inward

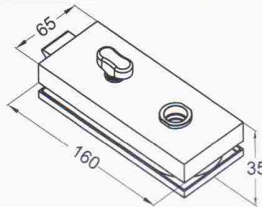

WL001R-O Outward

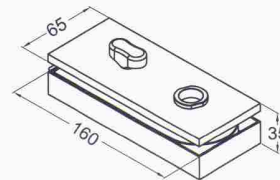

WL002R Inward

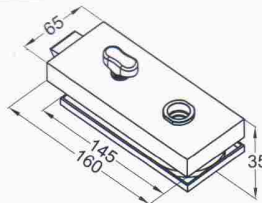

WL002R-O Outward

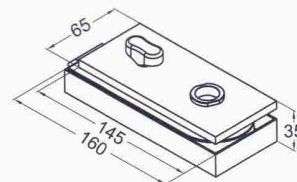

■ S Type(Length 160) NEW

PATENT RIGHT



WL001S Inward

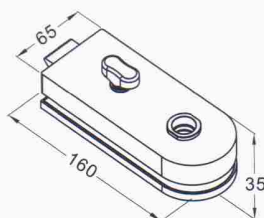

WL001S-O Outward

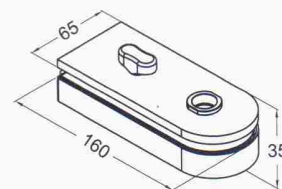

WL002S Inward

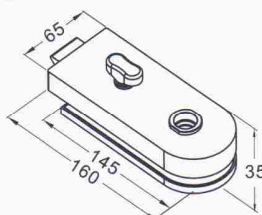

WL002S-O Outward

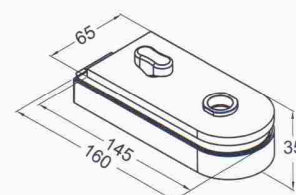

WASHROOM LOCK WITHOUT CYLINDER WL

Washroom Indication Lock Without Cylinder



Material	Material No.	Cover Finish
Stainless Steel	SUS304	PSS,BSS,PVD
	SUS316	
Aluminium	1050	AL,CL,DU,DB
Brass	C2680	PB,BSB

- { PSS:Polished Stainless Steel
- { BSS:Brushed Stainless Steel
- { PVD:Polished Zirconium
- { AL:Brushed Aluminium Anodizing
- { GD:Golden Yellow
- { DU:Duranodic Aluminium Anodizing
- { DB:Brushed Duranodic Aluminium Anodizing
- { PB:Polished Brass
- { BSB:Brushed Satin Brass

For 8mm(5/16")~12mm(1/2") Glass

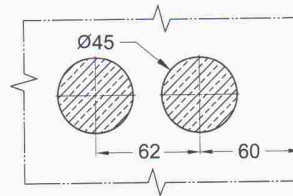
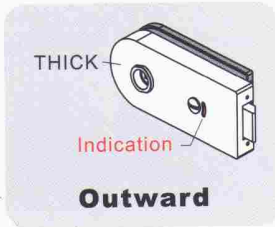
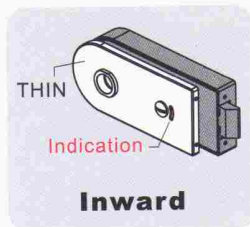

UNIT:mm

■ G Type (Length 175) NEW PATENT RIGHT

WLI001G Inward

WLI001G-O Outward

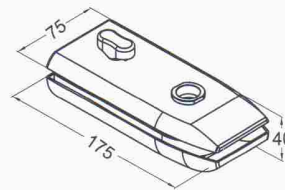
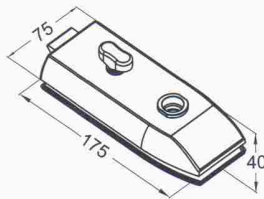

WLI002G Inward

WLI002G-O Outward

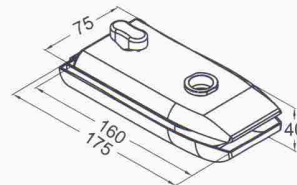
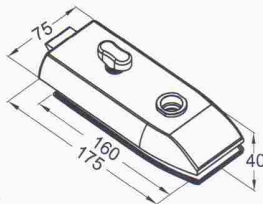

Material	Material No.	Cover Finish
Stainless Steel	SUS304	PSS, BSS, PVD
	SUS316	
Aluminium	1050	AL, CL, DU, DB
Brass	C2680	PB, BSB

- { PSS: Polished Stainless Steel
- { BSS: Brushed Stainless Steel
- { PVD: Polished Zirconium
- { AL: Brushed Aluminium Anodizing
- { GD: Golden Yellow
- { DU: Duranodic Aluminium Anodizing
- { DB: Brushed Duranodic Aluminium Anodizing
- { PB: Polished Brass
- { BSB: Brushed Satin Brass

For 8mm(5/16")~12mm(1/2") Glass

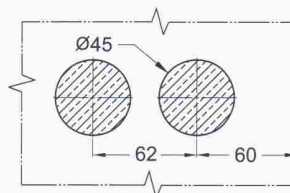
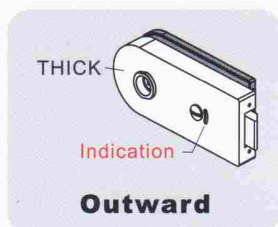
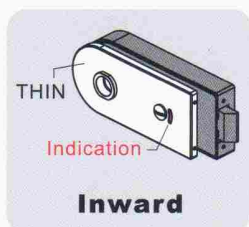

UNIT:mm

■ R Type (Length 160) NEW

PATENT RIGHT

WLI001R Inward

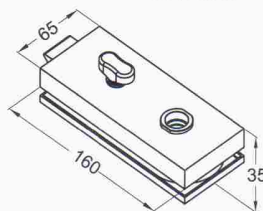

WLI001R-O Outward

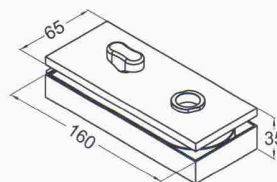

WLI002R Inward

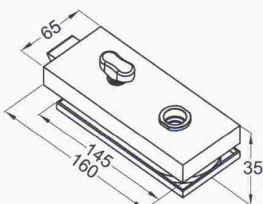

WLI002R-O Outward

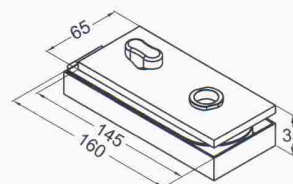

■ S Type (Length 160) NEW

PATENT RIGHT

WLI001S Inward

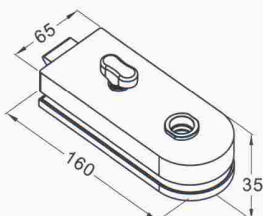

WLI001S-O Outward

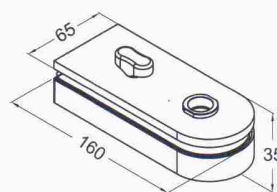

WLI002S Inward

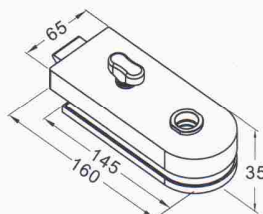

WLI002S-O Outward

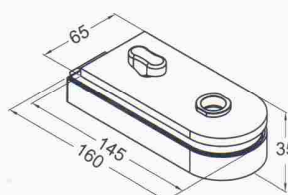

WASHROOM INDICATION LOCK WITHOUT CYLINDER WLI

NEW

Free Hinge



Material	Material No.	Cover Finish
Stainless Steel	SUS304	PSS,BSS,PVD

For 8mm(5/16")~12mm(1/2") Glass

- { PSS:Polished Stainless Steel
- { BSS:Brushed Stainless Steel
- { PVD:Polished Zirconium

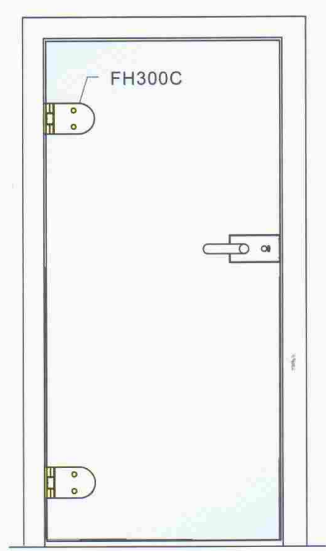

UNIT:mm

FH301C



FH301G

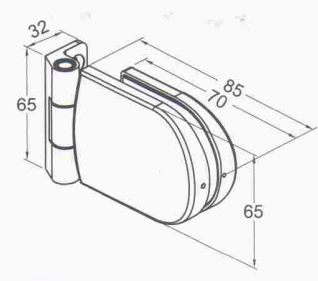

FH301R



FH301S

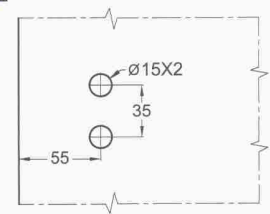
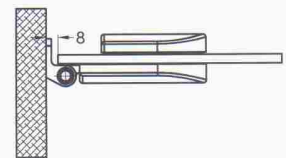

FH301C

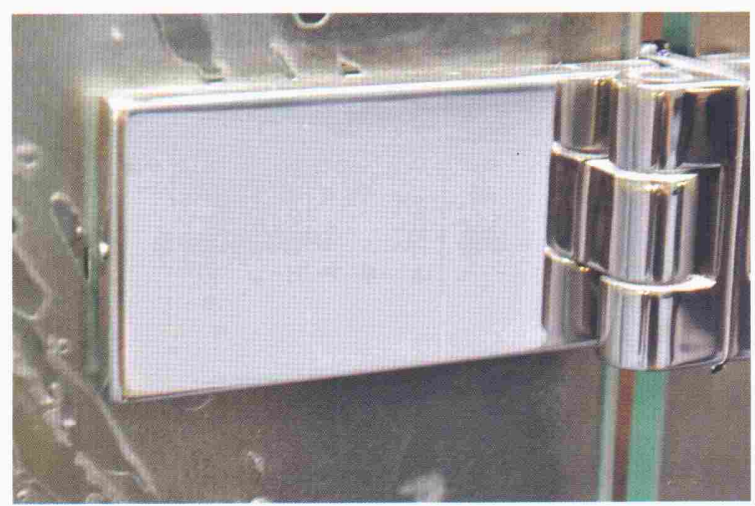

FREE HINGE
FH

Material	Material No.	Cover Finish
Stainless Steel	SUS304	PSS,BSS,PVD
	SUS316	
Aluminium	1050	AL,CL,DU,DB
Brass	C2680	PB,BSB

For 8mm(5/16")~12mm(1/2") Glass

- { PSS: Polished Stainless Steel
- { BSS: Brushed Stainless Steel
- { PVD: Polished Zirconium
- { AL: Brushed Aluminium Anodizing
- { GD: Golden Yellow
- { DU: Duranodic Aluminium Anodizing
- { DB: Brushed Duranodic Aluminium Anodizing
- { PB: Polished Brass
- { BSB: Brushed Satin Brass

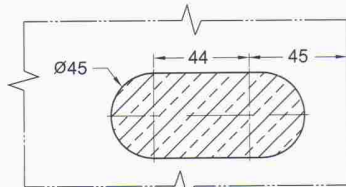
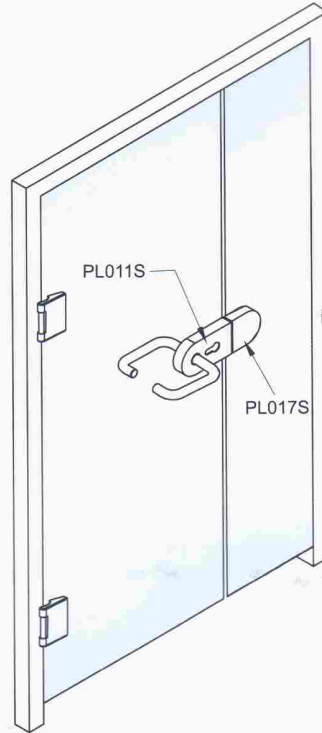

For PL011C/F/G/R/S~PL016C/F/G/R/S

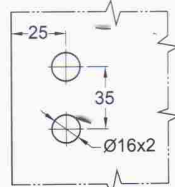

For PL017C/F/G/R/S
PL018C/F/G/R/S

UNIT:mm

■ C Type (Length 119) **PATENT RIGHT**



UNIT:mm

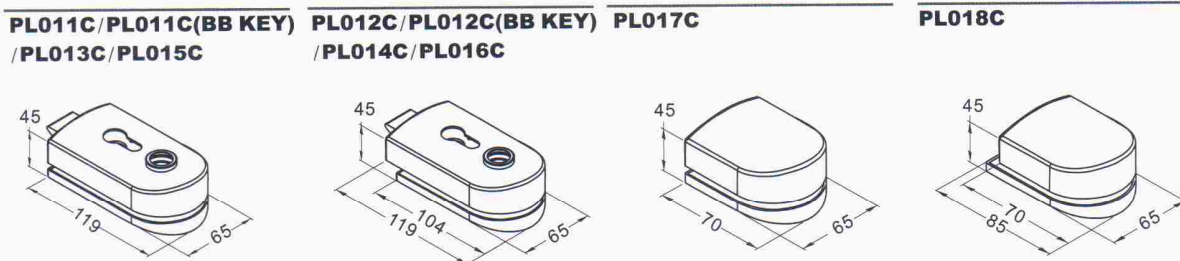

■ F Type (Length 120) PATENT RIGHT

Material: Brass Only

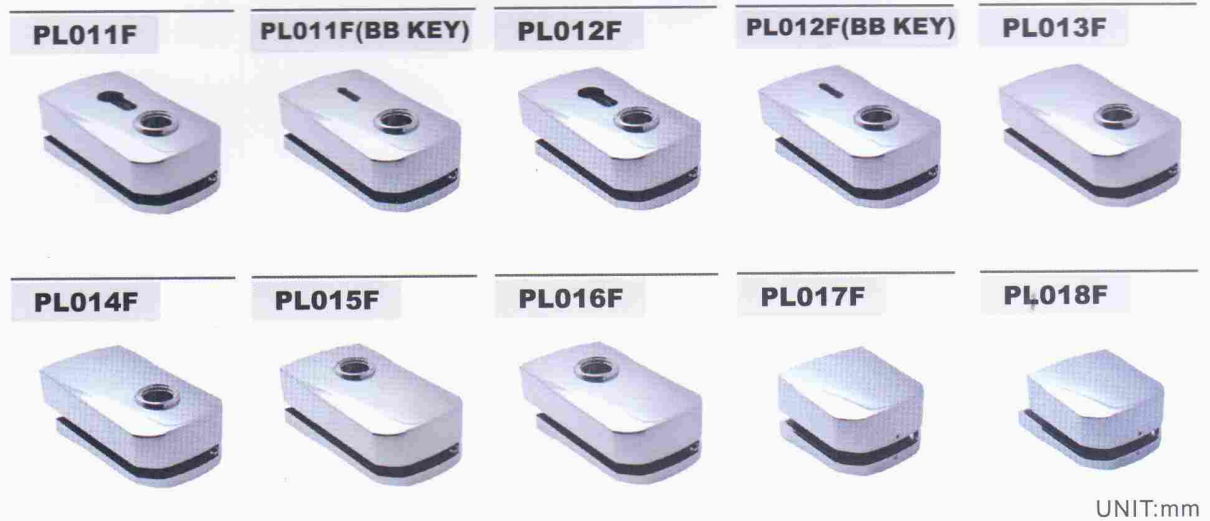

UNIT:mm

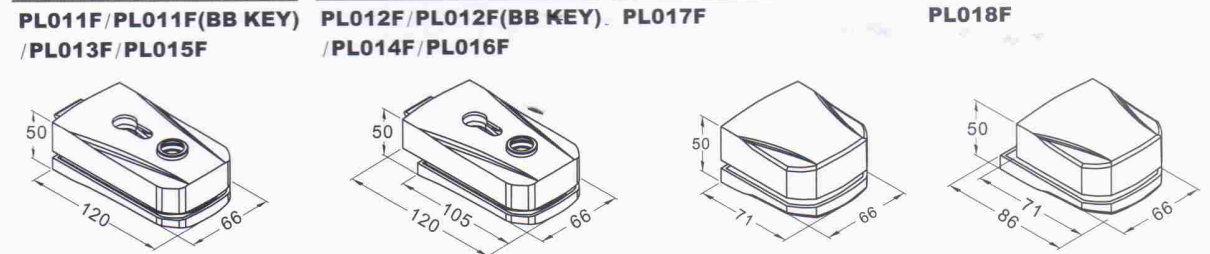

■ G Type (Length 142)



UNIT:mm

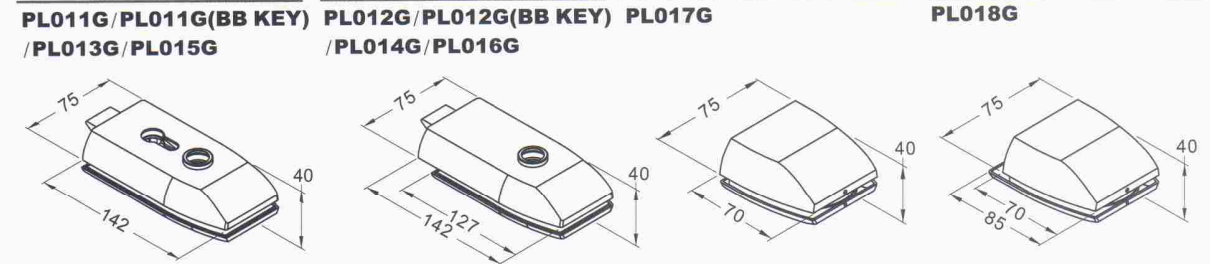

PATCH LOCK PL

■ R Type (Length 119) NEW



UNIT:mm

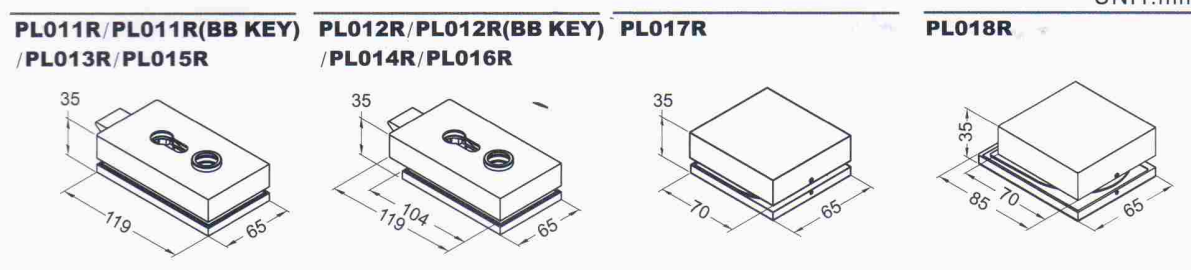

■ S Type (Length 119)

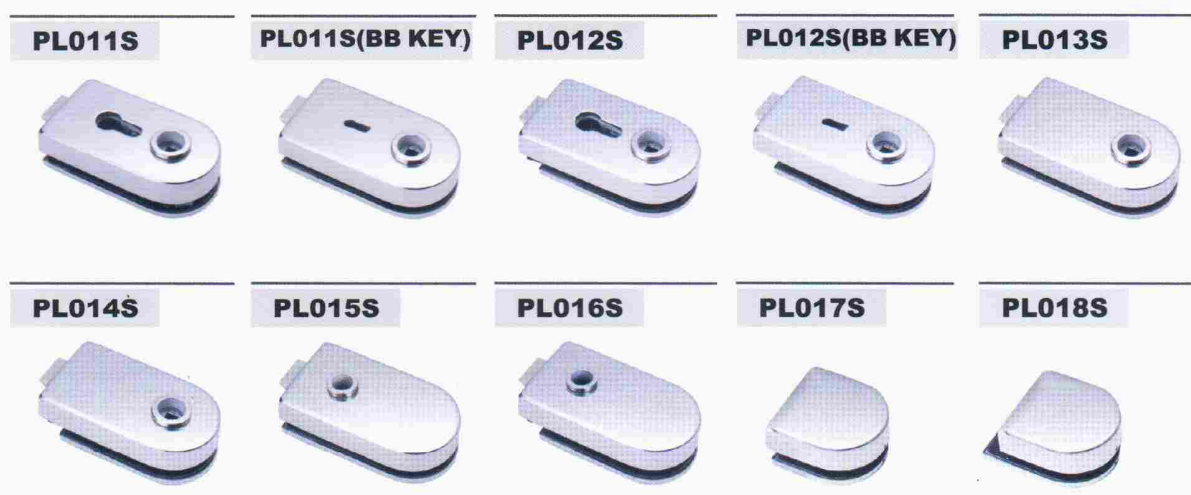

UNIT:mm

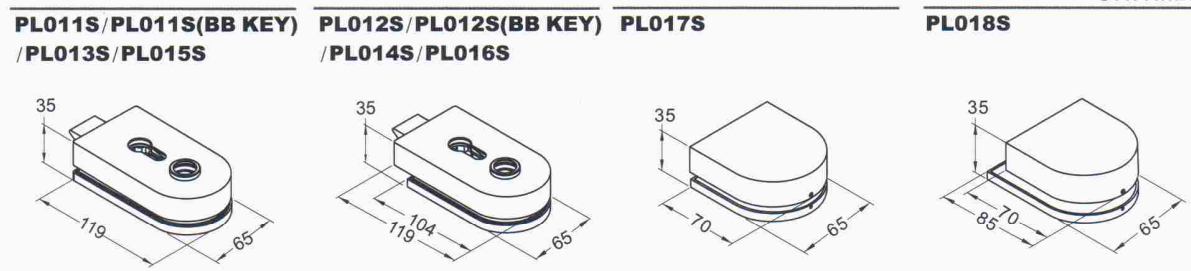

PATCH LOCK PL

Washroom Lock Without Cylinder



Material	Material No.	Cover Finish
Stainless Steel	SUS304	PSS,BSS,PVD
	SUS316	
Aluminium	1050	AL,CL,DU,DB
Brass	C2680	PB,BSB

- { PSS:Polished Stainless Steel
- { BSS:Brushed Stainless Steel
- { PVD:Polished Zirconium
- { AL:Brushed Aluminium Anodizing
- { GD:Golden Yellow
- { DU:Duranodic Aluminium Anodizing
- { DB:Brushed Duranodic Aluminium Anodizing
- { PB:Polished Brass
- { BSB:Brushed Satin Brass

For 8mm(5/16")~12mm(1/2") Glass

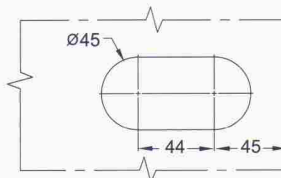
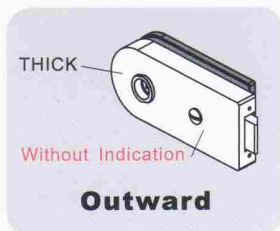
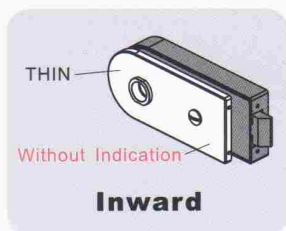

UNIT:mm

■ C Type(Length 119) NEW

PATENT RIGHT

WL011C Inward

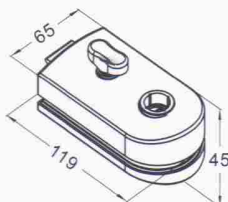

WL011C-O Outward

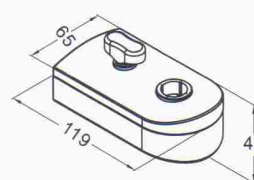

WL012C Inward

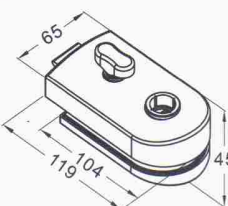

WL012C-O Outward

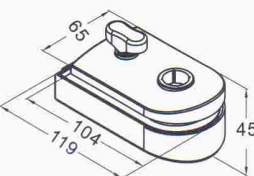

■ G Type(Length 142) NEW

PATENT RIGHT

WL011G Inward

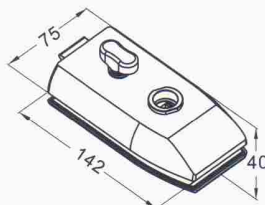

WL011G-O Outward

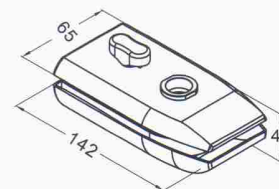

WL012G Inward

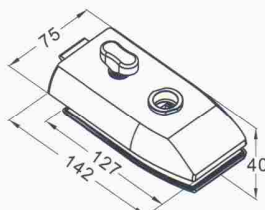

WL012G-O Outward

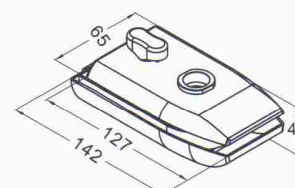

Keeper

UNIT:mm

KP01

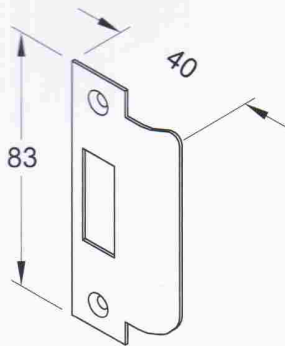

KP02

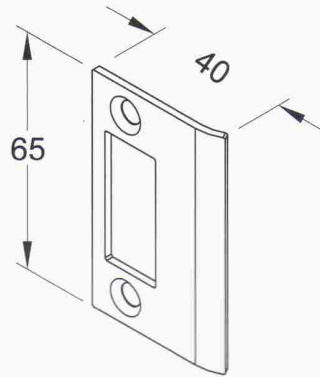

KP03

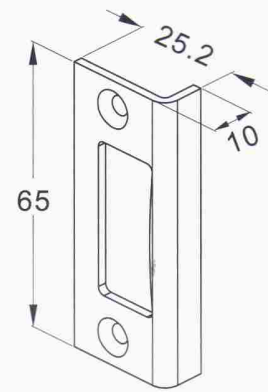

Strike Plate

PL01C

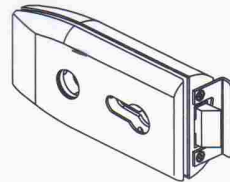
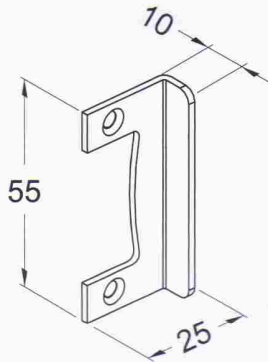

PL011G+PL01C

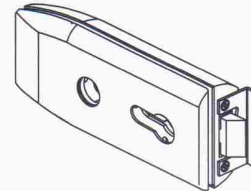

PL001G+PL01C

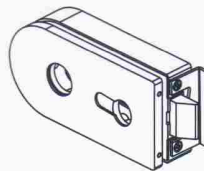

PL011S+PL01C

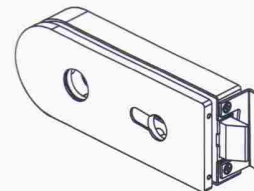

PL001S+PL01C

PL07C

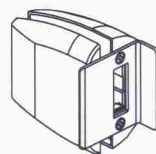
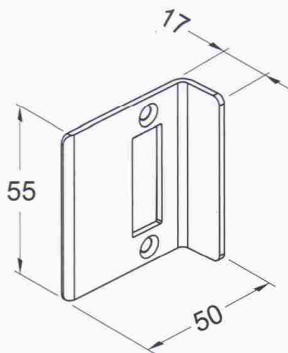

PL017G+PL07C

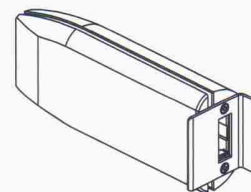

PL007G+PL07C

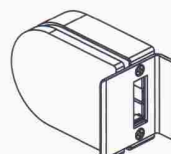

PL017S+PL07C

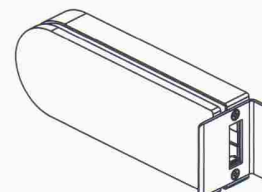

PL007S+PL07C

UNIT:mm

DC01 W/O Thumbturn

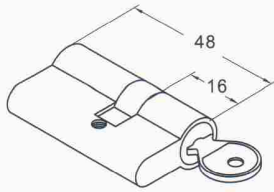

DC02 W/O Thumbturn

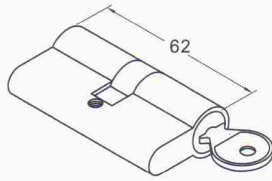

TC01 Thumbturn

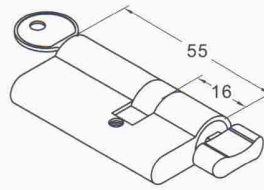

TC02 Thumbturn

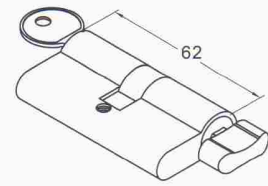

WC01-X (43L)

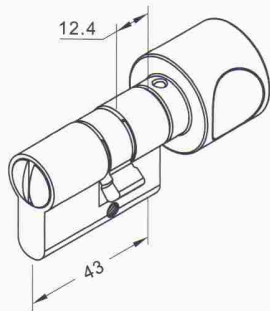

WC02-X (43S)

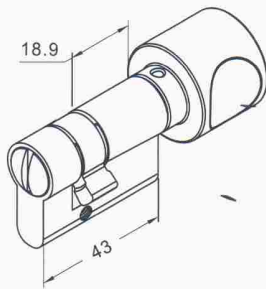

WC03-X (62L)

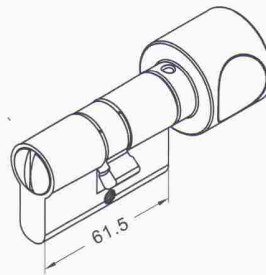

Cylinder

Finish

Polished Chrome
Nickel
Brass
Satin

Knob is alternative

A Type

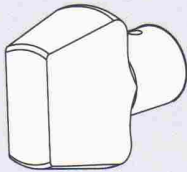

B Type

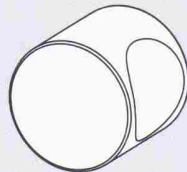

C Type

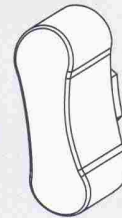

BB Key

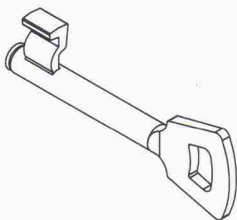

Finish

Polished Nickel



Material	Material No.	Finish
Stainless Steel	SUS304	PSS,BSS,PVD,BSC

PSS: Polished Stainless Steel
 BSS: Brushed Stainless Steel
 PVD: Polished Zirconium
 BSC: Brushed Satin Chrome

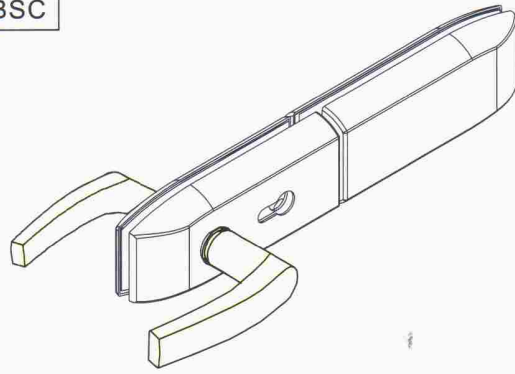

UNIT:mm

LH101

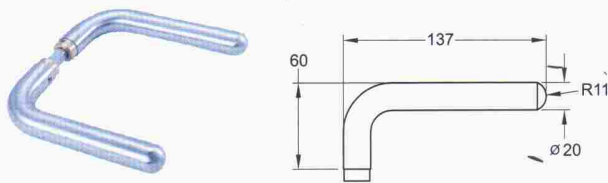

LH102

Material:Stainless Steel/Aluminium

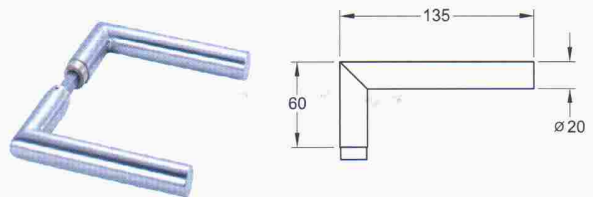

LH103

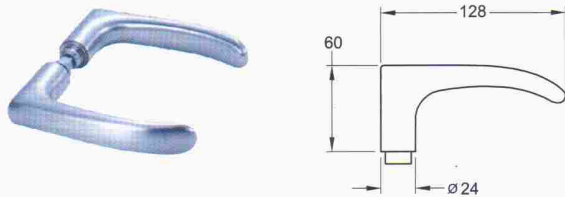

LH104

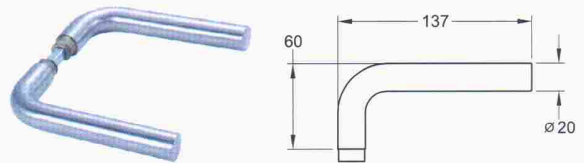

LH105

Material:Stainless Steel/Aluminium

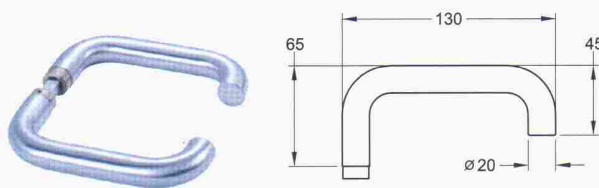

LH106

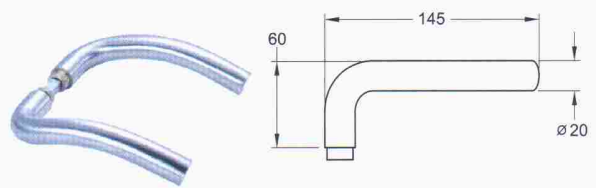

LH107

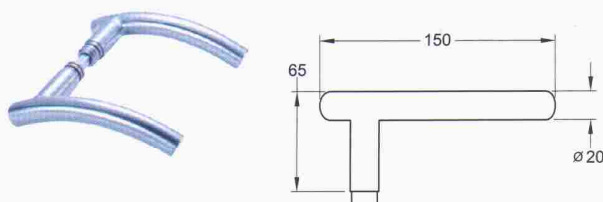

LH108

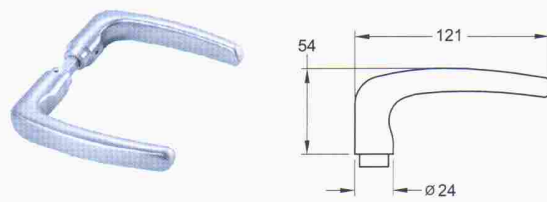

PATCH LOCK
 HANDLE
LH

LH109

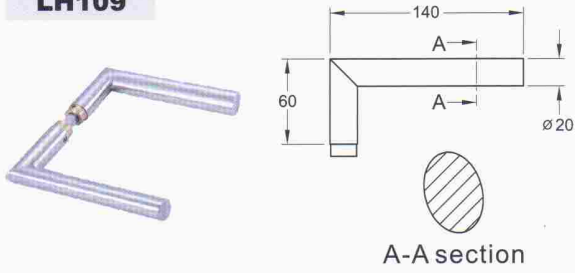

LH110 **NEW**

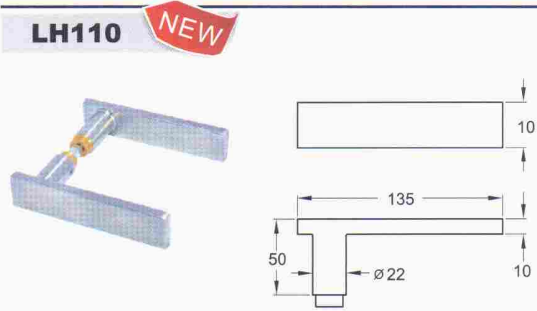

LH111 **NEW**

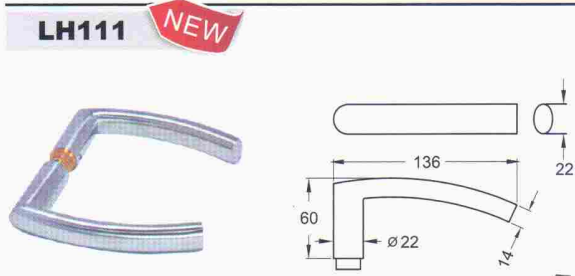

LH112 **NEW**

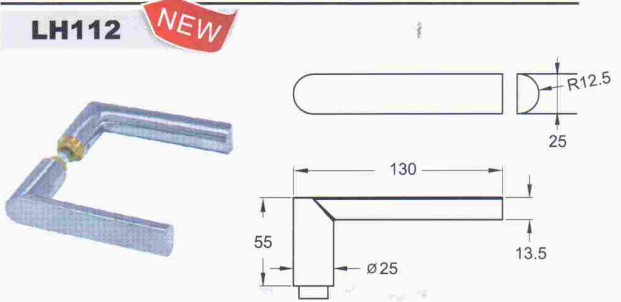

LH102S

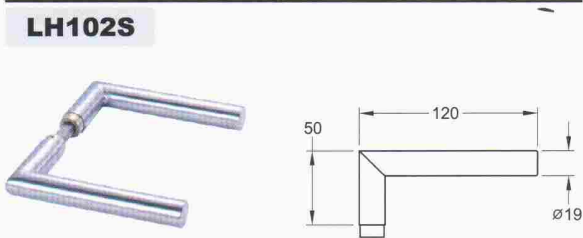

LH104S

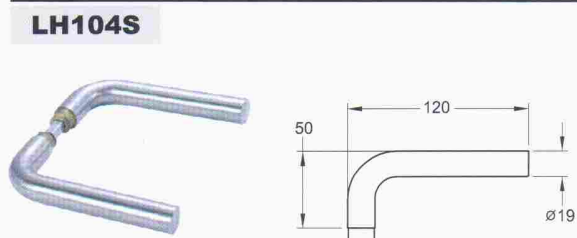

LH105S

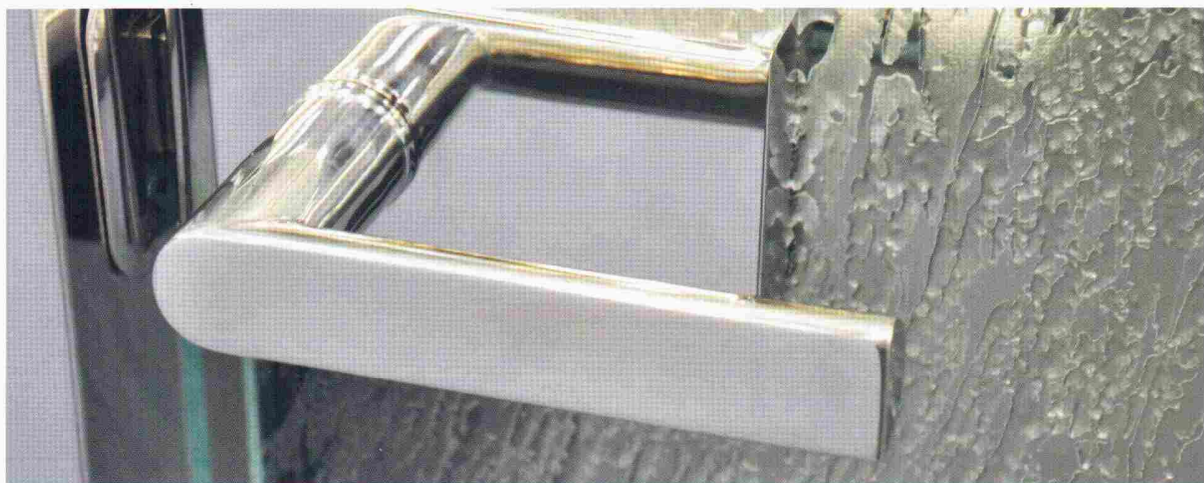
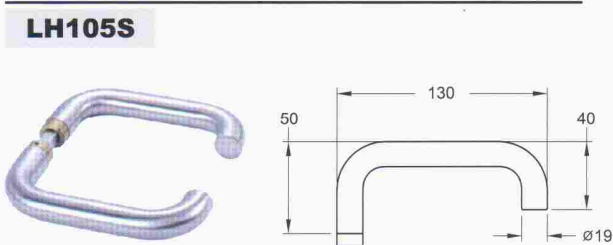

PATCH LOCK HANDLE

LH

Sliding Door (Flat Type)



Material	Material No.	Cover Finish
Stainless Steel	SUS316	PSS,BSS

PSS: Polished Stainless Steel
 BSS: Brushed Stainless Steel

Maximum Door Weight : 100kgs (220 lbs)
 For 10mm(3/8")~12mm(1/2") Glass

UNIT:mm

SD102F PATENT RIGHT

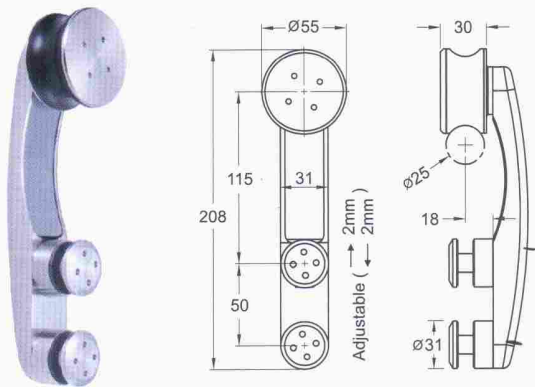

SD202F

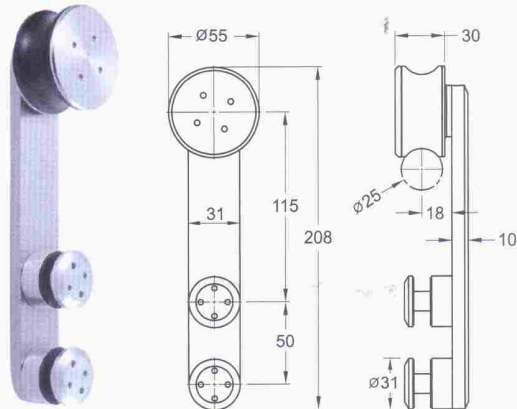

ROLLER	STOP	CLAMP FIXING	FLOOR GUIDE
SD102F	SD301	SD400	SD500
SD202F	SD300	SD400	SD500

ROLLER	STOP	CLAMP FIXING	FLOOR GUIDE
SD102F	SD301F	SD400F	SD500
SD202F	SD300F	SD400F	SD500

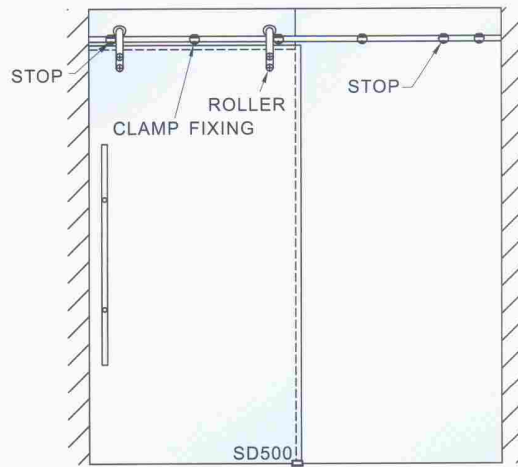
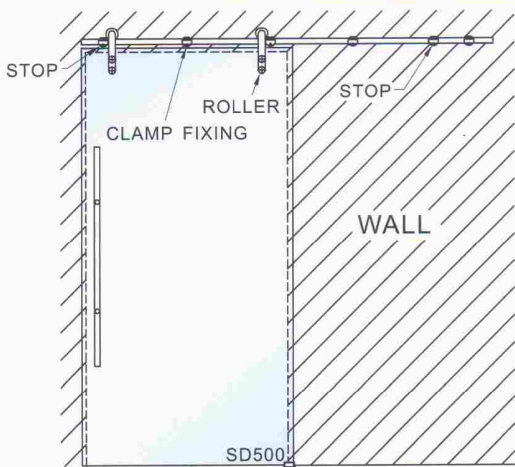

SD102F.SD202F

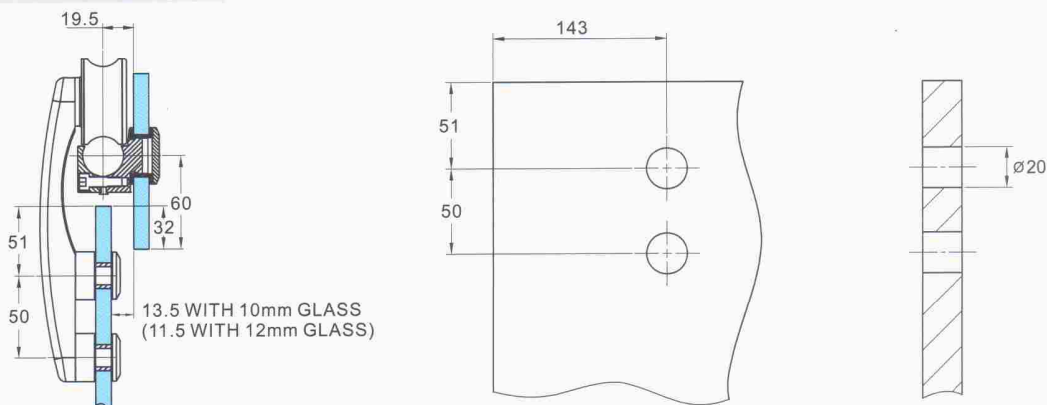

Sliding Door (Flat Type)

Material	Material No.	Cover Finish
Stainless Steel	SUS316	PSS,BSS

PSS: Polished Stainless Steel
 BSS: Brushed Stainless Steel

Maximum Door Weight : 100kgs (220 lbs)
 For 10mm(3/8")~12mm(1/2") Glass

UNIT:mm

SD102SF PATENT RIGHT

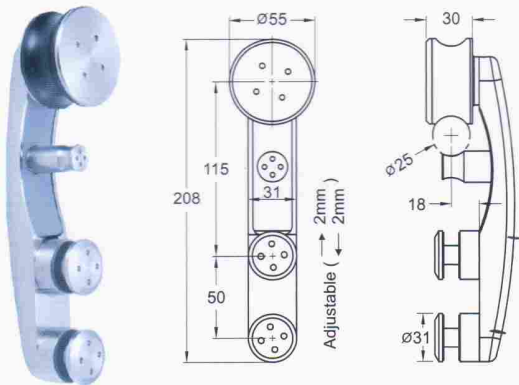

SD202SF

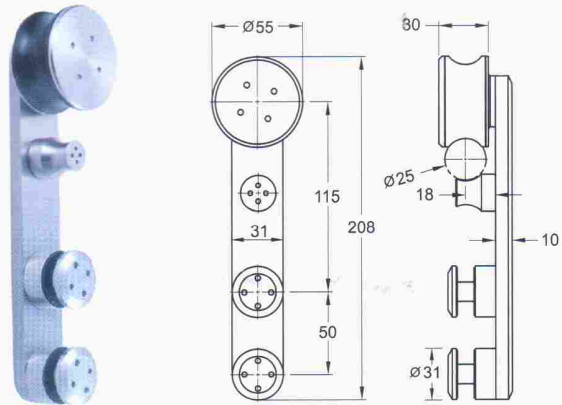

ROLLER	STOP	CLAMP FIXING	FLOOR GUIDE
SD102SF	SD301	SD401	SD500
SD202SF	SD300	SD401	SD500

ROLLER	STOP	CLAMP FIXING	FLOOR GUIDE
SD102SF	SD301F	SD401F	SD500
SD202SF	SD300F	SD401F	SD500

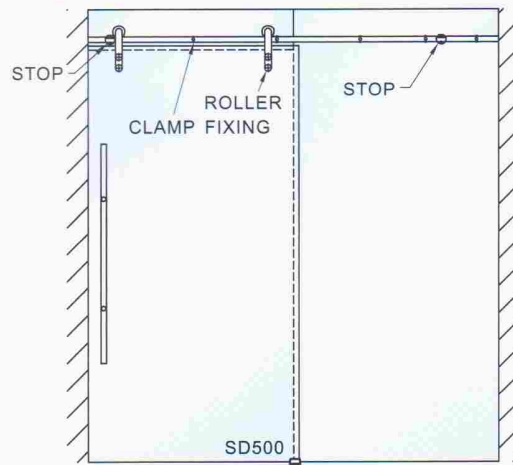
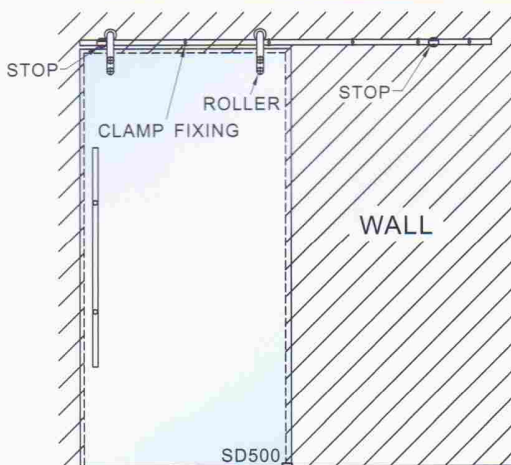

SD102SF.SD202SF

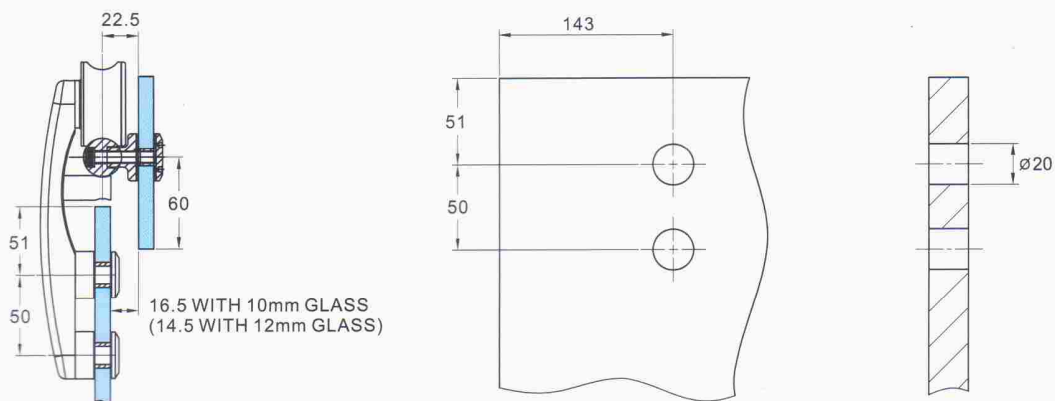

UNIT:mm

UNIT:mm

SD300C

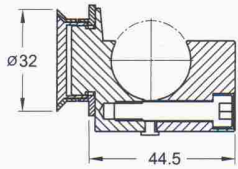

SD301C For SD102C/102SC

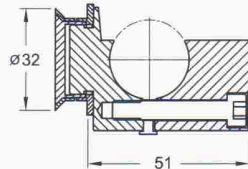

SD400C

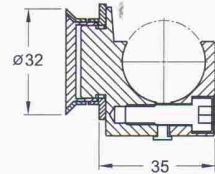

SD300F

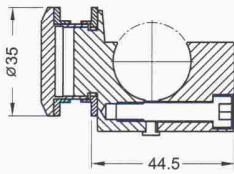

SD301F For SD102F/102SF

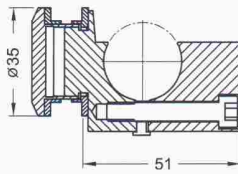

SD400F

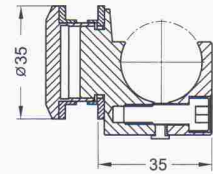

SD300

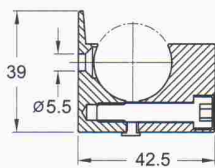

SD301 For SD102C/SD102SC
SD102F/SD102SF

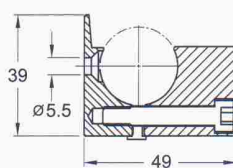

SD400

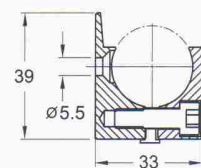

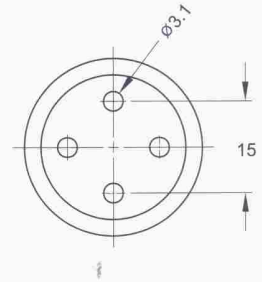
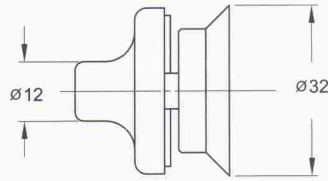
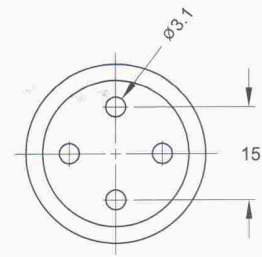
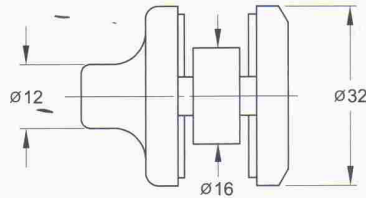
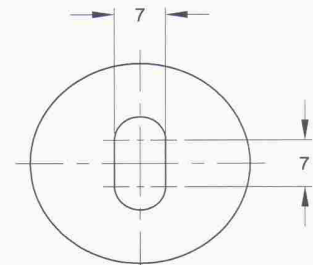
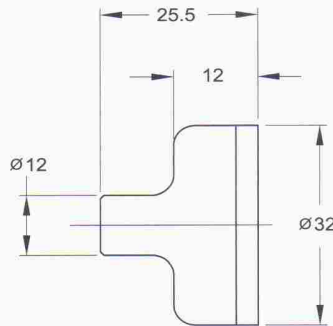
SD401C

SD401F

SD401

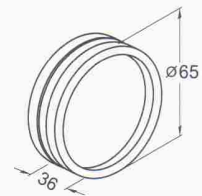
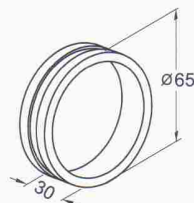
SDK01 Material : SUS316/Brass/Aluminium
For 10mm(3/8")~12mm(1/2")Glass

SDK02 Material : SUS316/Brass/Aluminium
For 10mm(3/8")~12mm(1/2") Glass



UNIT:mm

S01 50(Max.)~10(Min.)



S02-T Tube

S02-S Solid

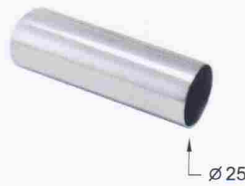

Length is 1000mm/2000mm
Material : SUS316

S03 END CAP

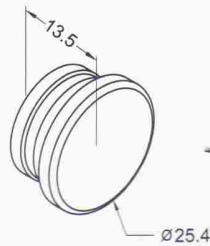

SD500 Material : Zinc Finish :AN,PSC
For 8mm(5/16")~12mm(1/2") Glass

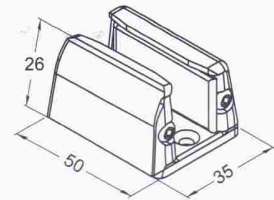
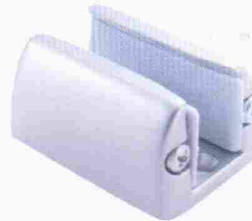

SD600

SD601-Keeper

Material : AL6063/SUS304
For 10mm(3/8")~12mm(1/2") Glass

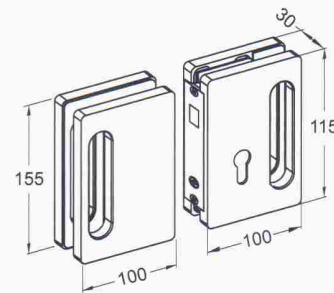

SD900 **NEW**

SD901-Keeper **NEW**

Material : SUS304
For 8mm(5/16")~12mm(1/2") Glass

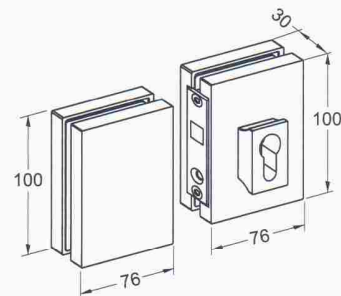

GC03075C

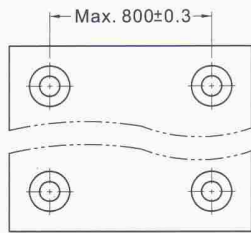

Countersink holes from the front side

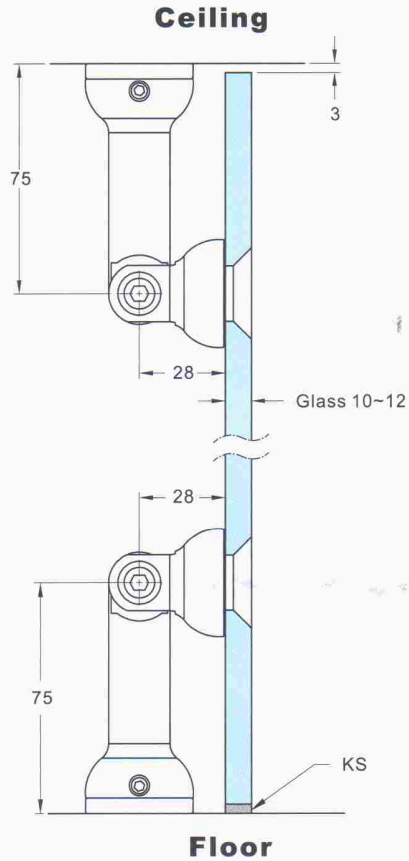
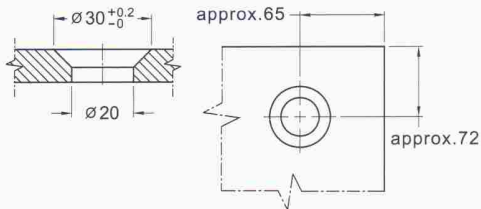

GC04140C

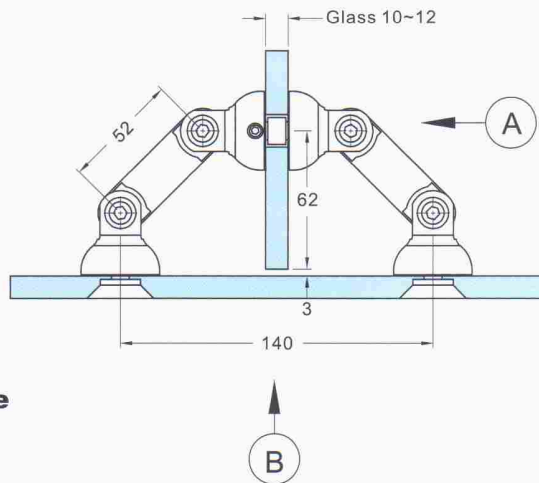
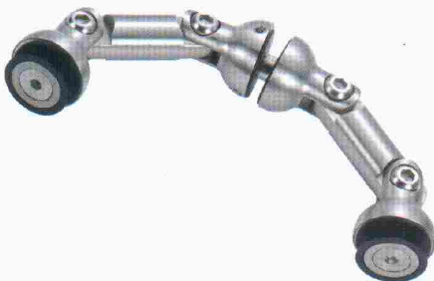

Countersink holes from the front side

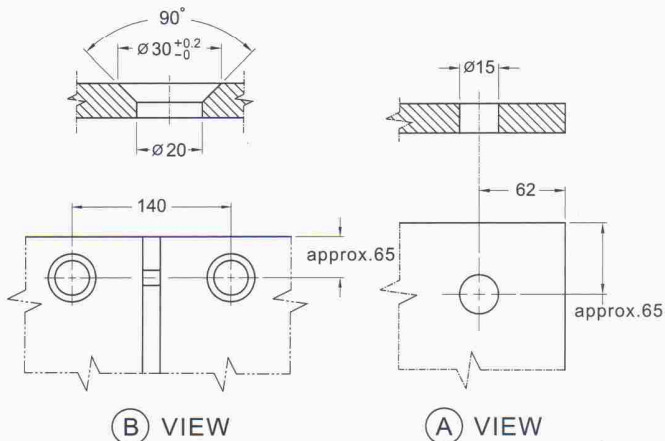

SFXXX XXXC (Cambered Type)

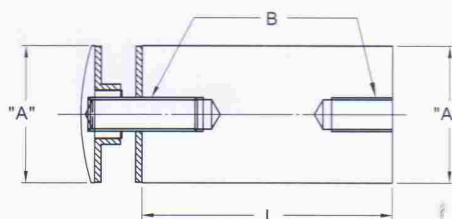
 Material : SUS304 · SUS316 · Brass · Aluminum
 For 8mm(5/16")~12mm(1/2") Glass

Catalog No.		B dimension	D dimension	L dimension	Type
Item	A dimension				
SF	ø1/2"(12.70)	#10-24UNC	ø10	1/4" (6.35mm) 1/2" (12.7mm) 3/4" (19.05mm) 1" (25.4mm) 1 1/2" (38.1mm)	C
	ø3/4"(19.05)	1/4-20UNC	ø12	1/4" (6.35mm) 1/2" (12.7mm) 3/4" (19.05mm)	
	ø1"(25.40)	1/4-20UNC	ø12	1" (25.4mm) 1 1/2" (38.1mm)	
	ø1 1/2"(38.10)	3/8-16UNC	ø15	2" (50.8mm)	
	ø1 1/4"(31.75)	5/16-18UNC	ø15	4" (101.6mm)	
	ø2"(50.8)	3/18-16UNC	ø16	6" (152.4mm)	

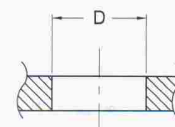
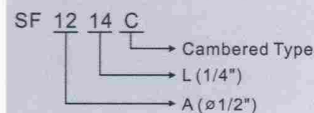
Glass CUT OUT

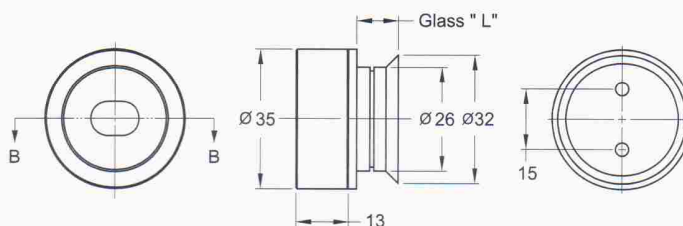
Example

SF13812C (Countersink Type)

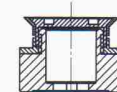
 Material : SUS304 · SUS316
 For 6mm(1/4")~12mm(1/2") Glass

Item	Glass "L"
A	10mm~12mm
B	8mm~10mm
C	6mm~8mm

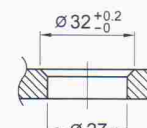

SECTION B-B

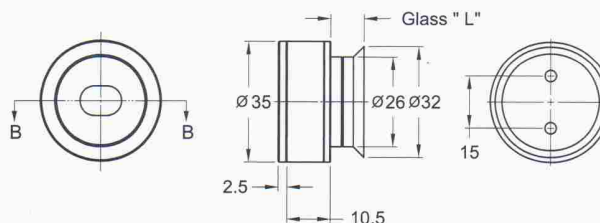

Glass CUT OUT
SF13812AC (Countersink Type)

 Material : SUS304 · SUS316
 For 6mm(1/4")~12mm(1/2") Glass

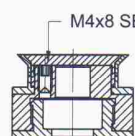
Item	Glass "L"
A	10mm~12mm
B	8mm~10mm
C	6mm~8mm

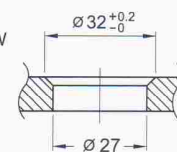

SECTION B-B

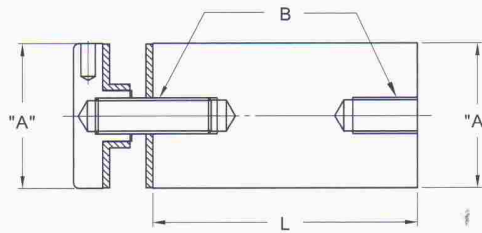

Glass CUT OUT

SFXXX XXXF

 Material : SUS304 · SUS316 · Brass · Aluminum
 For 8mm(5/16")~12mm(1/2") Glass

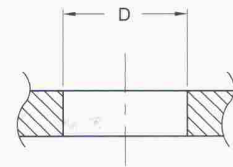
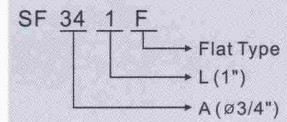
Catalog No.		B dimension	D dimension	L dimension	Type
Item	A dimension				
SF	∅1/2"(12.70)	#10-24UNC	∅10	1/4" (6.35mm) 1/2" (12.7mm) 3/4" (19.05mm) 1" (25.4mm) 1 1/2" (38.1mm)	F
	∅3/4"(19.05)	1/4-20UNC	∅12	1/4" (6.35mm) 1/2" (12.7mm)	
	∅1"(25.40)	1/4-20UNC	∅12	3/4" (19.05mm) 1" (25.4mm)	
	∅1 1/2"(38.10)	3/8-16UNC	∅15	1 1/2" (38.1mm)	
	∅1 1/4"(31.75)	5/16-18UNC	∅15	2" (50.8mm) 4" (101.6mm)	
	∅2"(50.8)	3/18-16UNC	∅16	6" (152.4mm)	

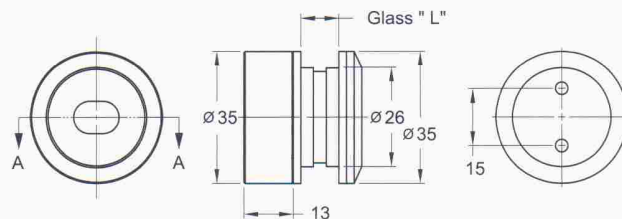
Glass CUT OUT

Example

SF13812F

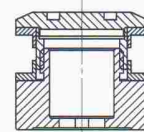
 Material : SUS304 · SUS316
 For 6mm(1/4")~12mm(1/2") Glass

Item	Glass "L"
A	10mm~12mm
B	8mm~10mm
C	6mm~8mm



SECTION A-A

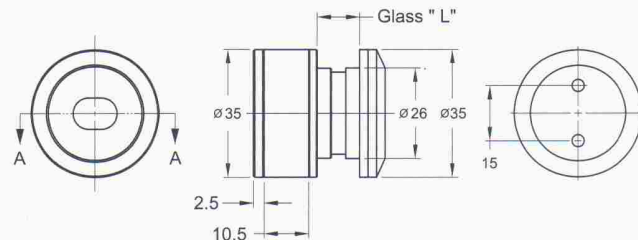

Glass CUT OUT
SF13812AF

 Material : SUS304 · SUS316
 For 6mm(1/4")~12mm(1/2") Glass

Item	Glass "L"
A	10mm~12mm
B	8mm~10mm
C	6mm~8mm

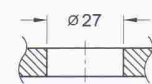

SECTION A-A

Glass CUT OUT

Material : SUS316
For 6mm(1/4")~10mm(3/8") Glass

UNIT:mm

BC045

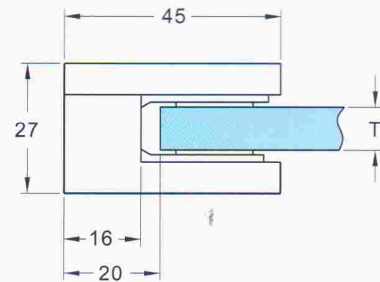
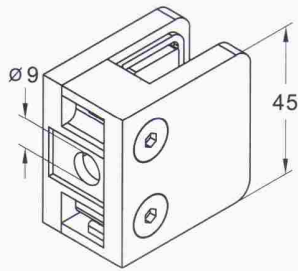

BC047

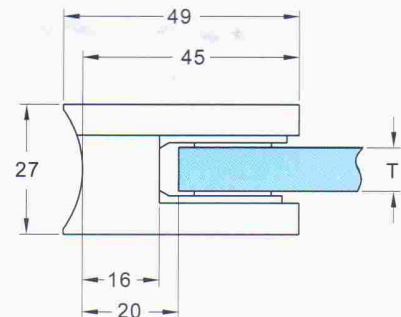
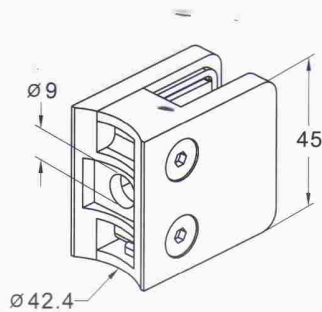

BC050

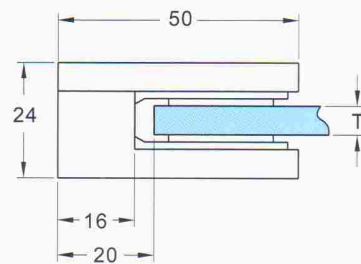
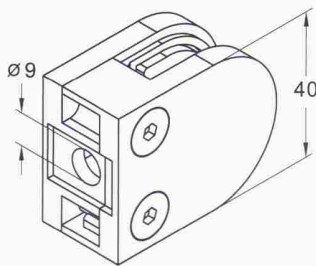

BC052

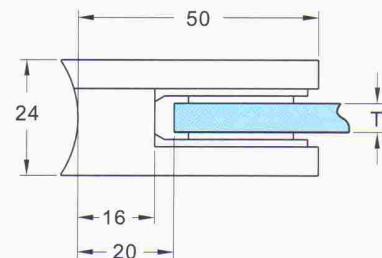
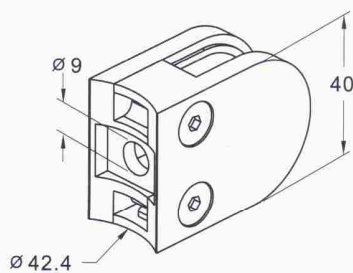

Balustrade Glass Clip

Material : SUS316
For 6mm(1/4")~12mm(1/2") Glass

UNIT:mm

BC055

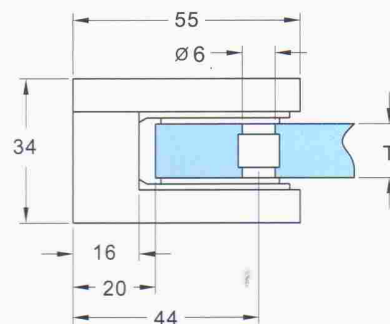
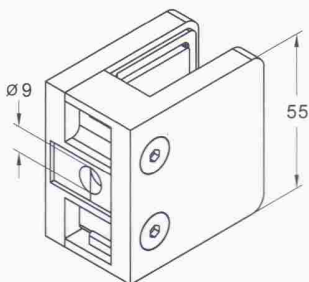

BC060

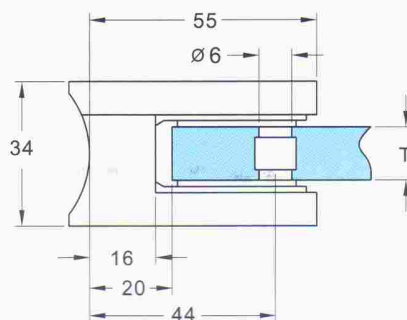
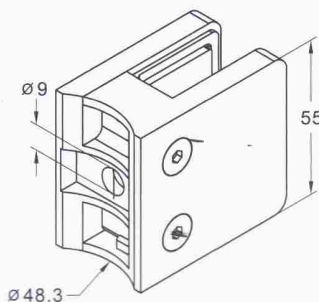

BC062

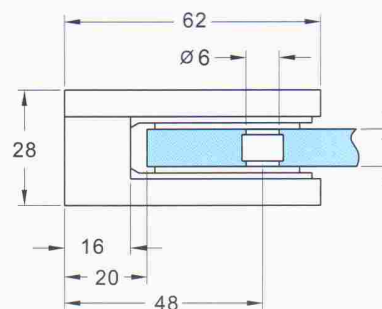
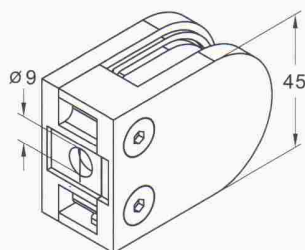

BC066

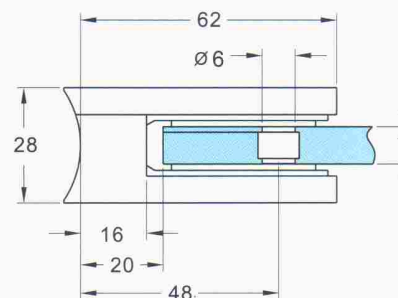
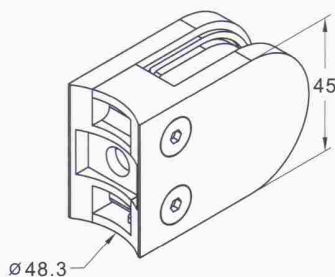

Professional Glass Channel Systems

Material : SUS304/SUS316 Length : 6000mm

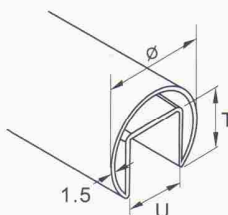

Item No.	U	T	ø
BCT01	24	24	42.4
BCT02	27	30	48.3

Material : SUS316
Finish : PSS/BSS

UNIT:mm

SF001

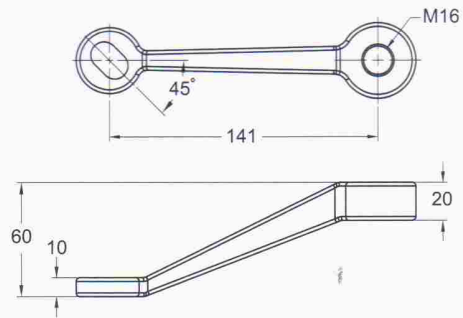

SF002

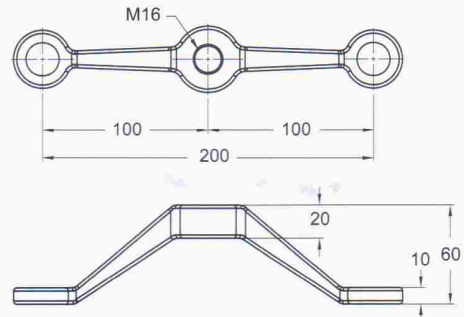

SF003

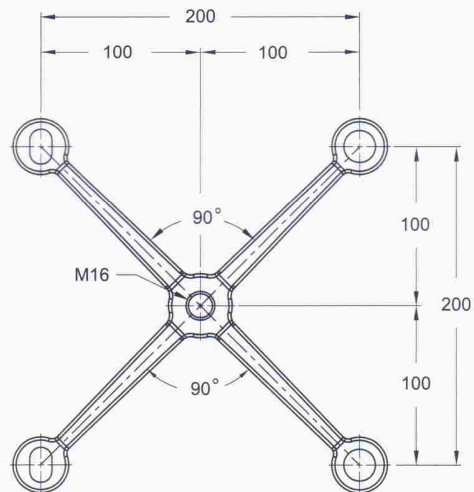

SF004

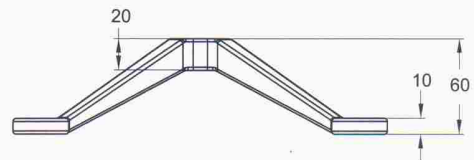

SF005

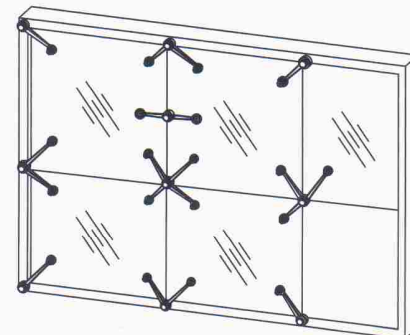

Material : SUS316

UNIT:mm

SF006

Finish : PSS/BSS

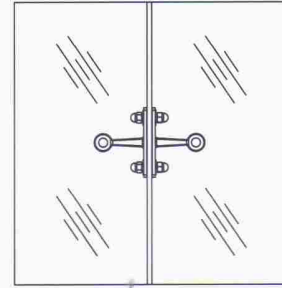
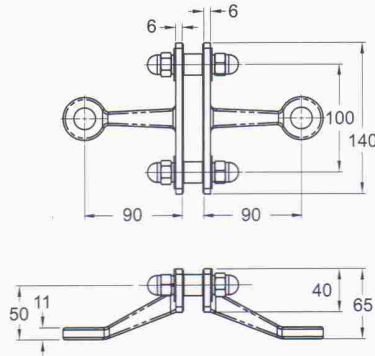

SF007

Finish : PSS/BSS

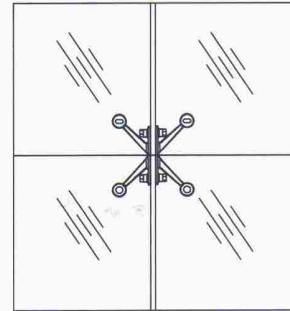
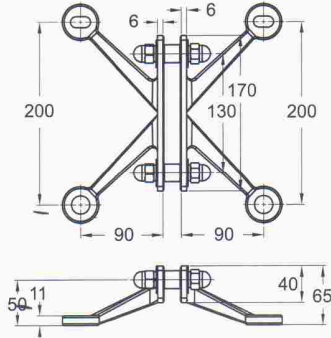

SF008

Finish : PSS/BSS



Type	A	B	C
SF008-12	12	45	12
SF008-15	15	50	15
SF008-19	19	55	19

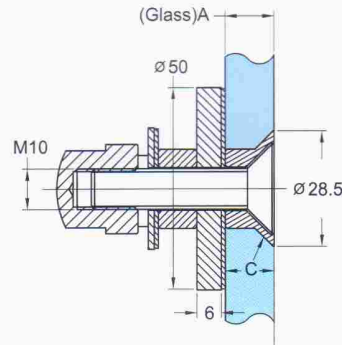

Glass Cut-Out

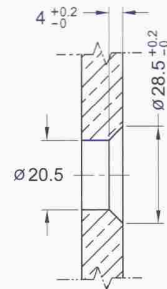

SF009

For 12mm(1/2")~16mm(5/8") Glass

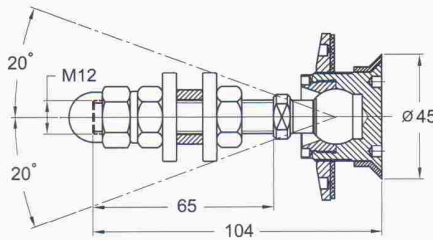

Glass Cut-Out

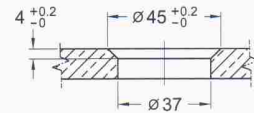

SF010

For 12mm(1/2") Glass

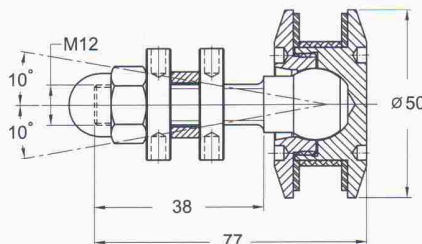

Glass Cut-Out

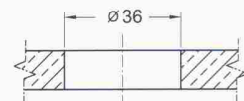

ES200

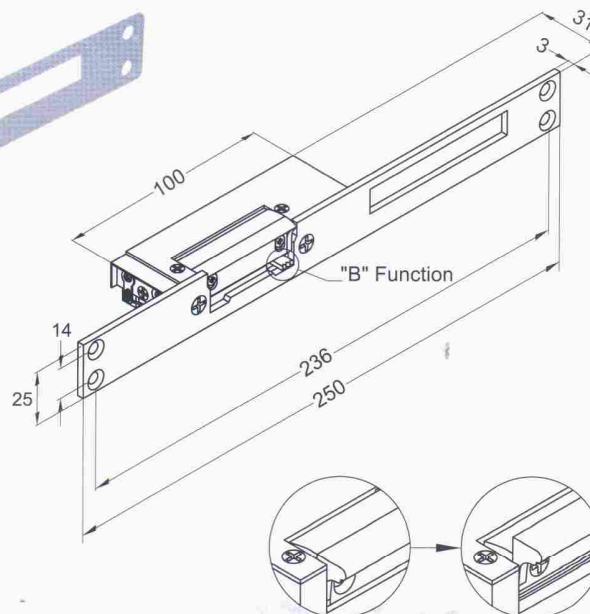
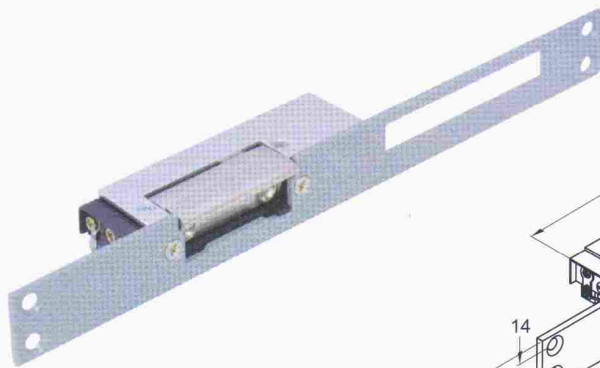

CHARACTERISTIC

1. Electric Strike for Fail-Safe & Fail-Secure.
2. Mechanical Unlatching. ("B" Function)
3. Suitable for Wooden Door and Metal Door.

NOTICE

1. Suitable for Opening by Left and Right.
2. Workable with Card, Key, Passcode, Remote Control and Push Bottom Switch.

MODEL	INPUT VOLTAGE
ES200	12VDC/360mA
ES200B	12VAC/600mA
	24VDC/120mA

ES250

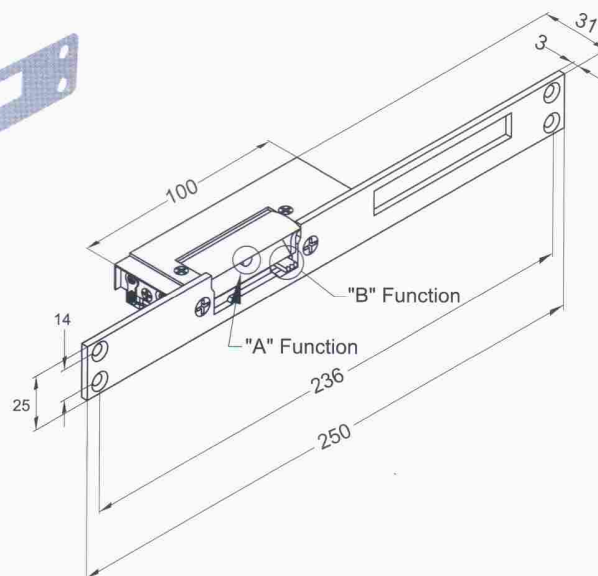
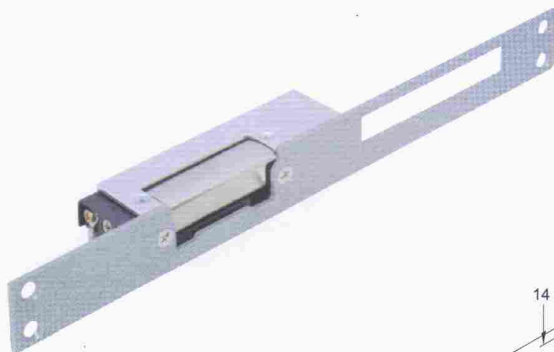

CHARACTERISTIC

1. Electric Strike for Fail-Safe & Fail-Secure.
2. Mechanical Unlatching. ("B" Function)
3. Automatic Open After Electric Impulse ("A" Function)
4. Suitable for Wooden Door and Metal Door.

NOTICE

1. Suitable for Opening by Left and Right.
2. Workable with Card, Key, Passcode, Remote Control and Push Bottom Switch.

MODEL	INPUT VOLTAGE
ES250	12VDC/360mA
ES250A	12VAC/600mA
ES250B	24VDC/120mA
ES250AB	

Glass Clip



GC500 Series

The glass clips are suitable for glass 8mm (5/16") ~ 12mm (1/2").

Material: Brass

UNIT:mm

GLASS CLIP
GC

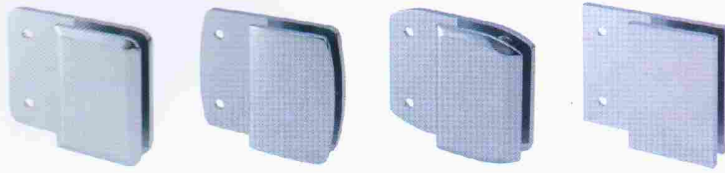

GC506B

GC506C

GC506G

GC506S

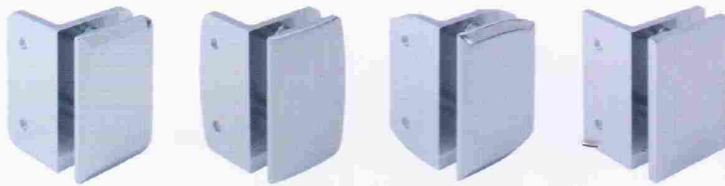
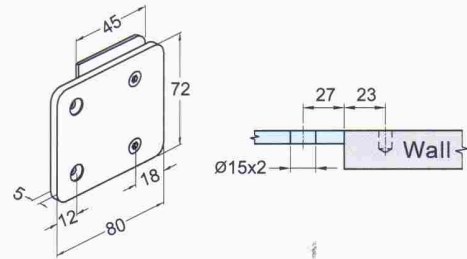

GC507B

GC507C

GC507G

GC507S

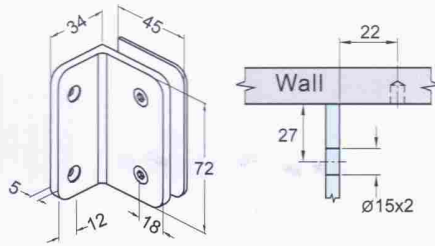

GC508B

GC508C

GC508G

GC508S

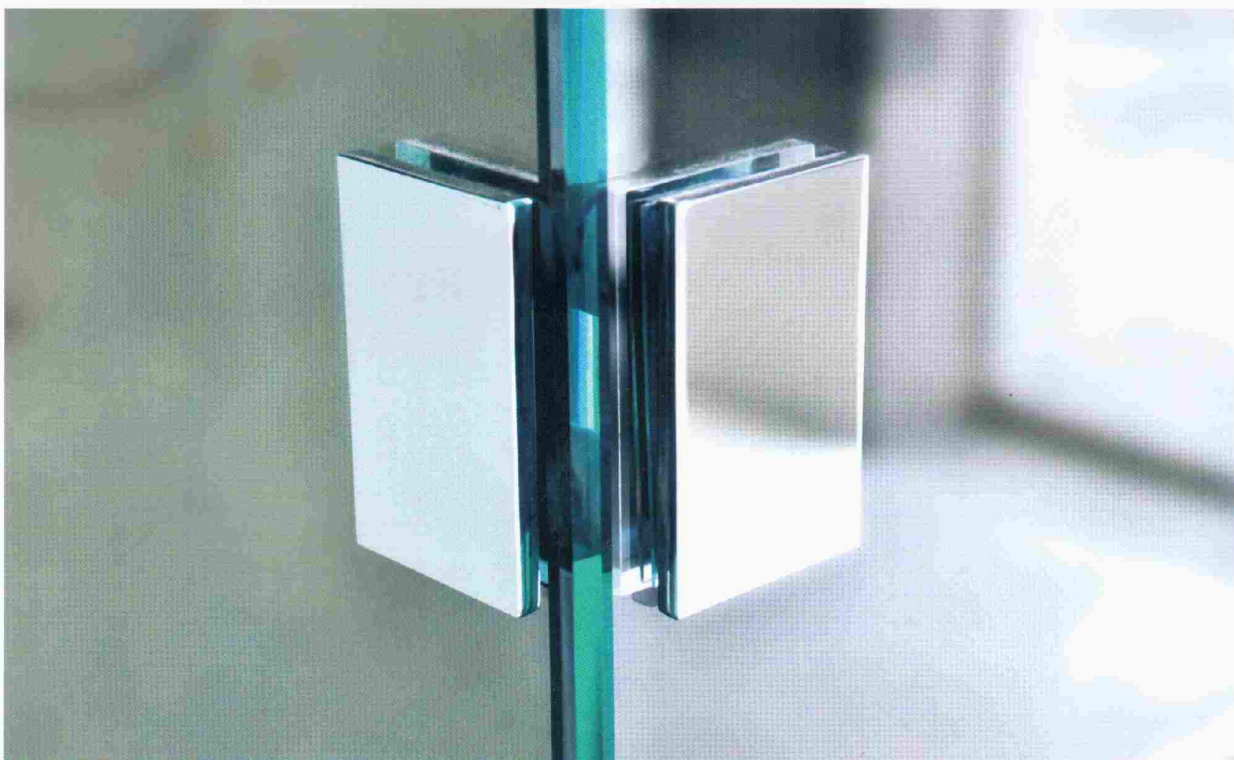
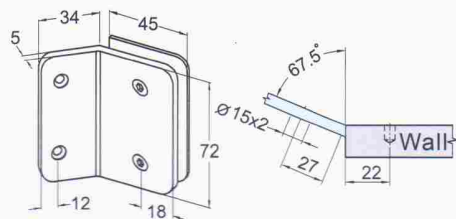

04 OUR MAJOR PRODUCT LINE: Commercial door hardware • Shower door hardware • Glass door lock • Cabinet hardware • Electric strike

©Please go to the website for more details. www.gangwo.com.tw

2011.8

GC700 Series

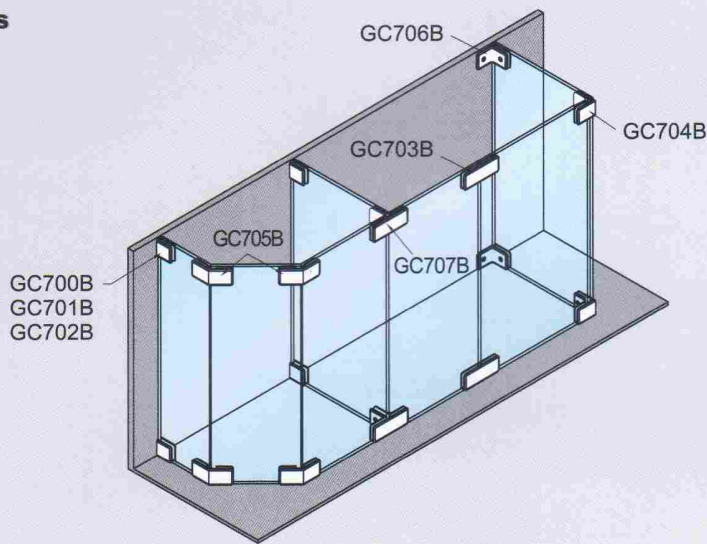

The glass clips are suitable for glass 10mm (3/8") ~ 12mm (1/2").
Material: Brass

UNIT:mm



GC700B



GC700S

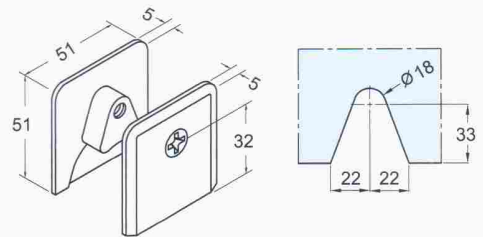

GC701B

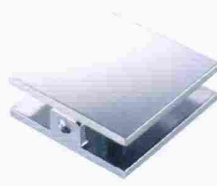

GC701S



GC701G

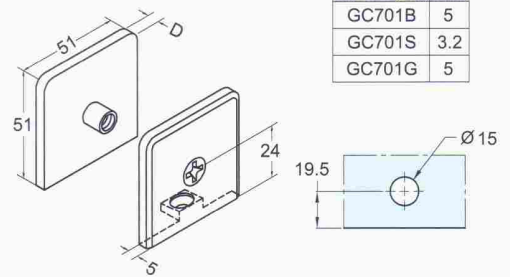

GC702B



GC702S

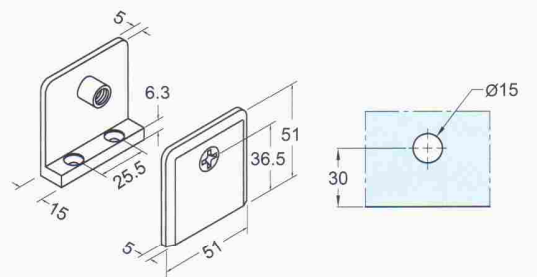

GC700 Series

The glass clips are suitable for glass 10mm (3/8") ~ 12mm (1/2").

Material: Brass

UNIT:mm



GC703B

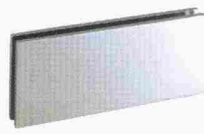

GC703S



GC703G

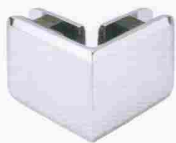
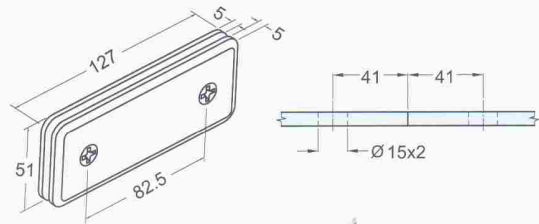

GC704B

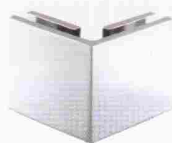

GC704S



GC704G

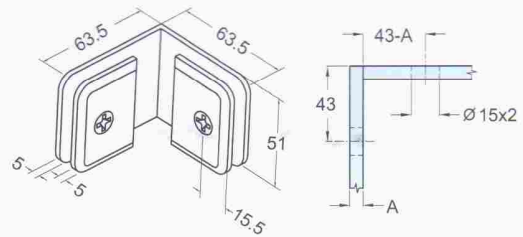

GC705B



GC705S



GC705G

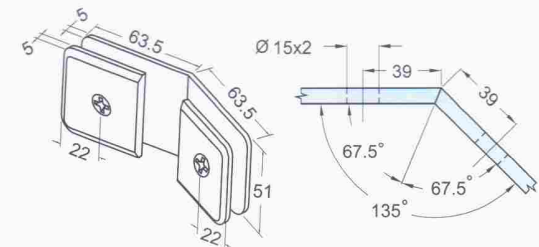

GC706B

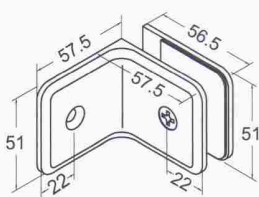

GC706G

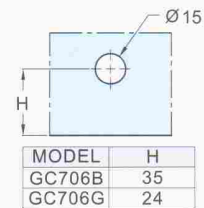
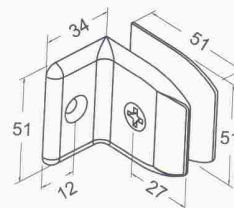

GC707B

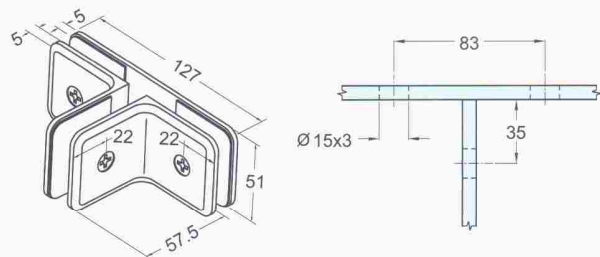

GC800 Series
PATENT RIGHT For C Type

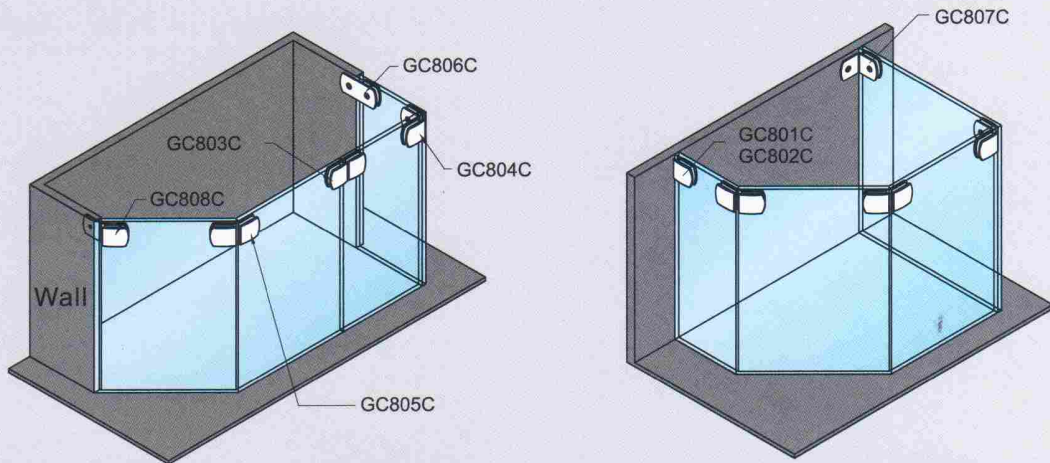

The glass clips are suitable for glass 8mm(5/16") ~ 10mm(3/8")
 Material:Brass

UNIT:mm



GC801C



GC801S

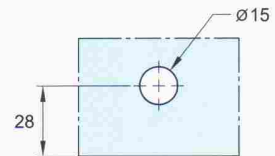
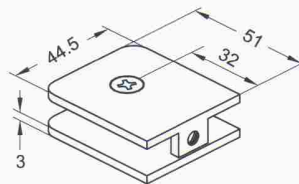

GC802C



GC802S

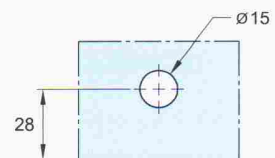
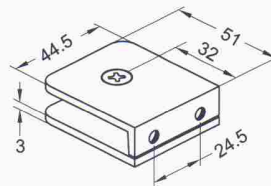

GC803C



GC803S

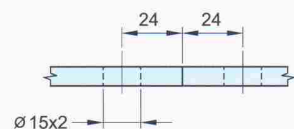
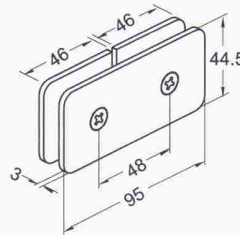

GC804C



GC804S

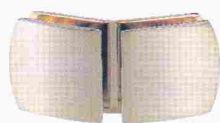
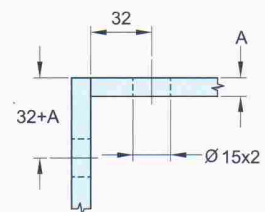
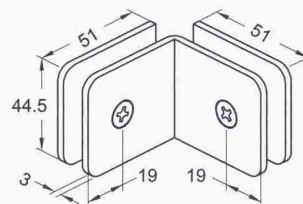

GC805C



GC805S

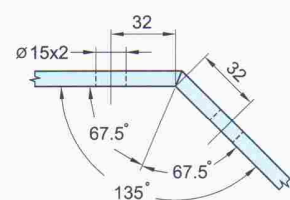
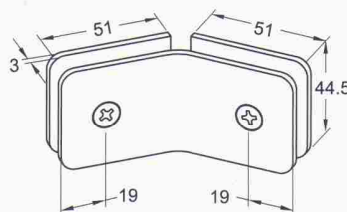

Glass Clip



GC800 Series **PATENT RIGHT For C Type**

The glass clips are suitable for glass 8mm (5/16") ~ 10mm (3/8")

Material: Brass

UNIT:mm



GC806C



GC806S

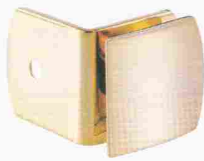
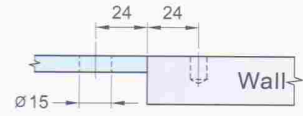
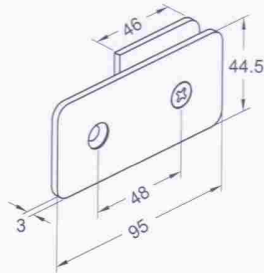

GC807C



GC807S

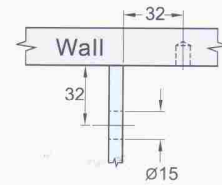
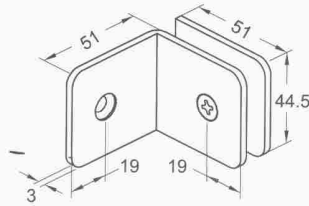

GC808C



GC808S

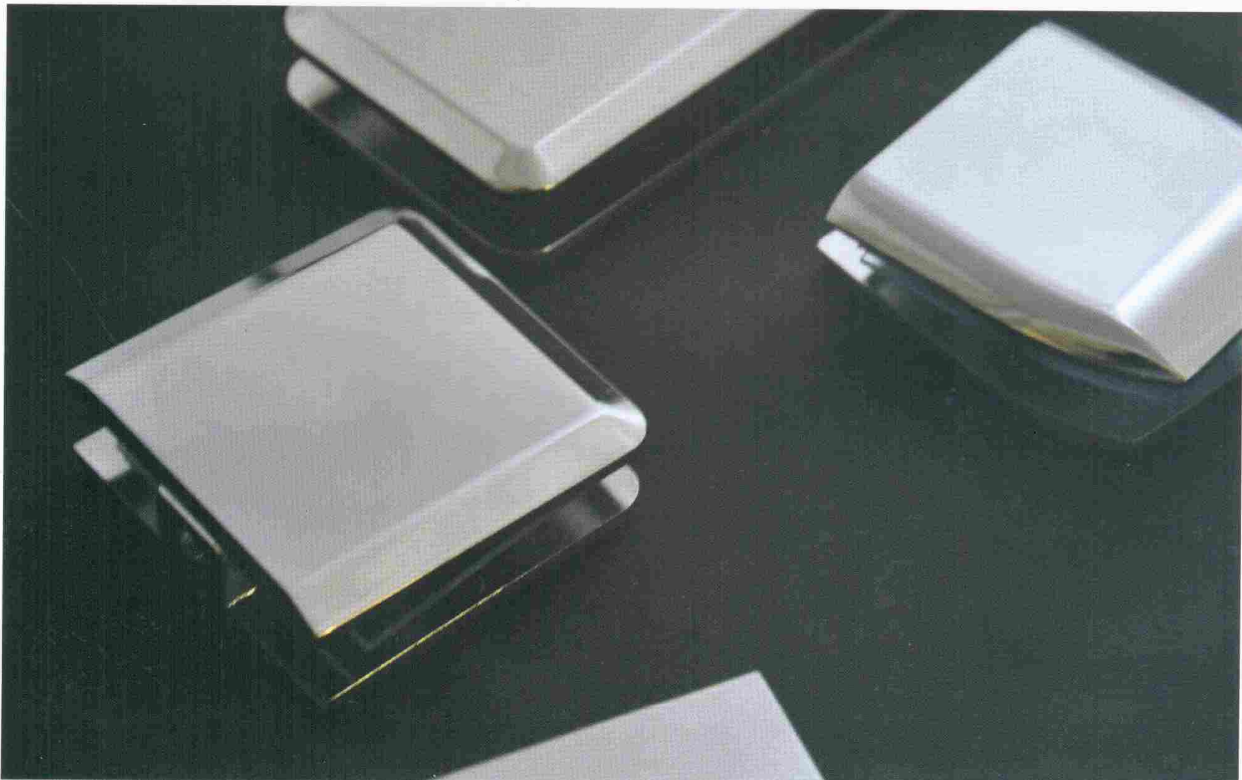
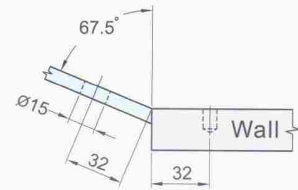
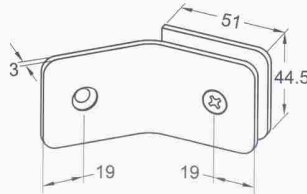

Free Hinge

FH100G Series

Material: Brass

Maximum Capacities	8mm(5/16")		10mm(3/8")	
	Weight	Door Width	Weight	Door Width
Using 2 Hinges	36kgs (80 / lbs)	711mm (28")	36kgs (80 / lbs)	711mm (28")
Using 3 Hinges	50kgs (110 / lbs)	813mm (32")	50kgs (110 / lbs)	813mm (32")

UNIT:mm



FH100G

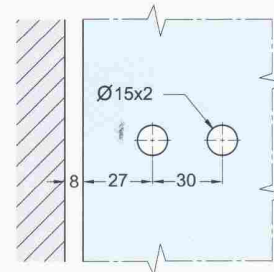
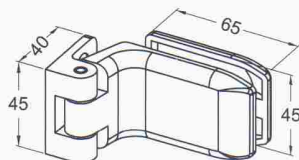

FH101G

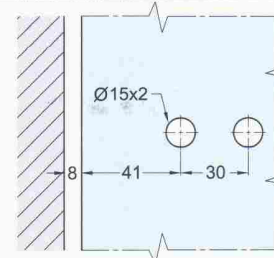
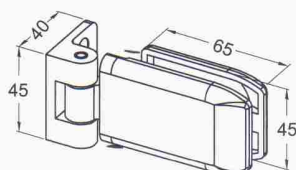

FH102G

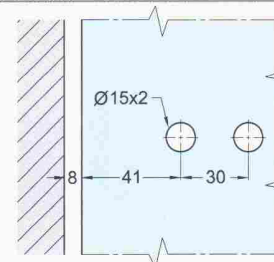
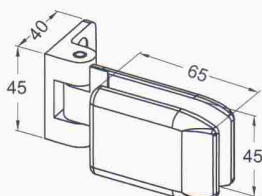

FH103G

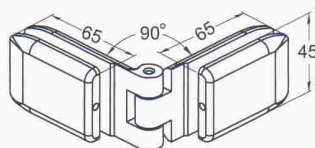
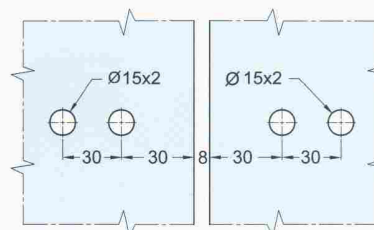
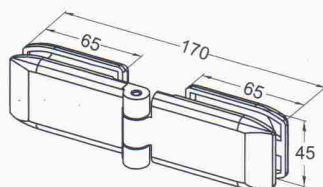

Glass to glass for 90°

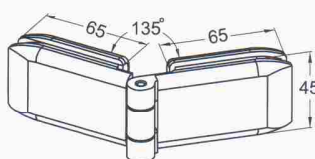
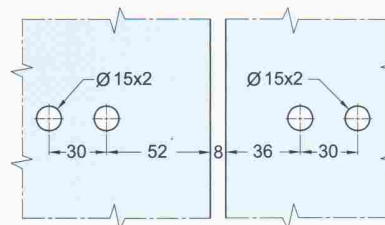

Glass to glass for 135°

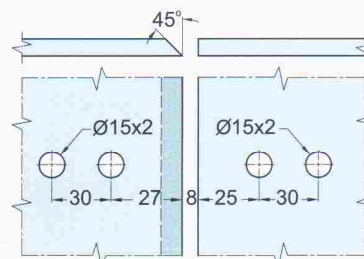

FH800R Series

Material: Brass

Maximum Capacities	6mm(1/4")		8mm(5/16")	
	Weight	Door Width	Weight	Door Width
Using 2 Hinges	28kgs (62 / lbs)	711mm (28")	28kgs (62 / lbs)	711mm (28")
Using 3 Hinges	42kgs (92 / lbs)	813mm (32")	42kgs (92 / lbs)	813mm (32")

UNIT:mm



FH801R

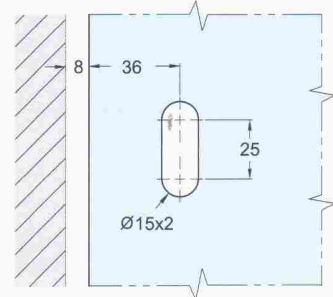
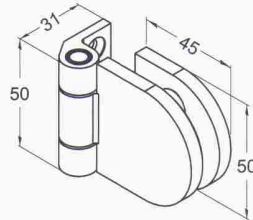

FH802R

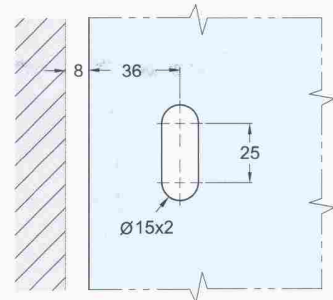
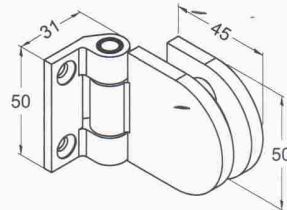

FH803R

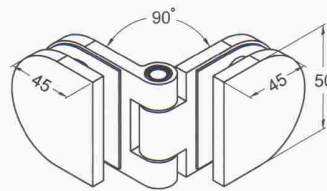
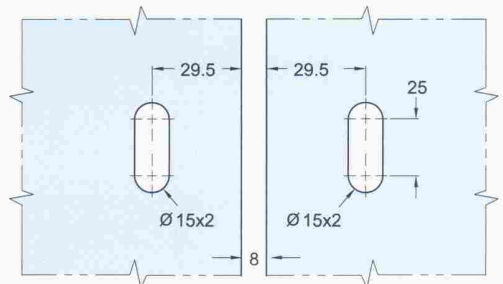
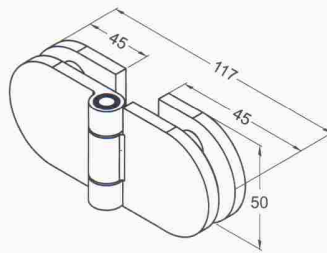

Glass to glass for 90°

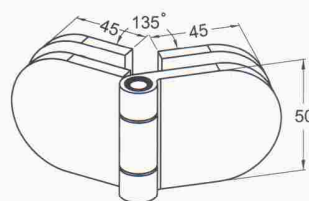
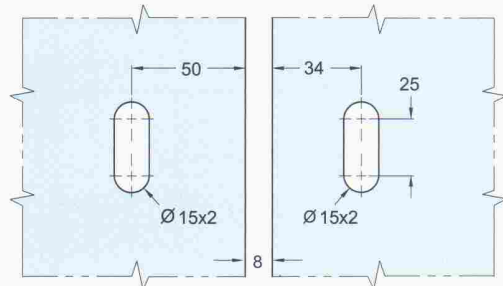

Glass to glass for 135°

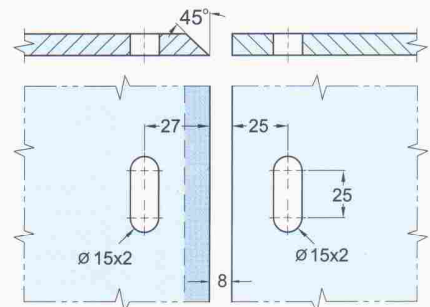



AH400C series



AH300C series



AH300G series



AH600G series

ADJUSTMENT SPECIFICATION SHEET

STEPS:

1. Insert M3 hexagon spanner(A) into hexagon screw hole.
2. Turn hexagon spanner counterclockwise 3 times to loosen hexagon screw.
(NOTE : Do not turn more than 3 times otherwise the internal spring will be loosen)
3. Adjust glass door to a desired angle.
4. Turn hexagon panner clockwise to fasten hexagon screw.

Adjustment Angle

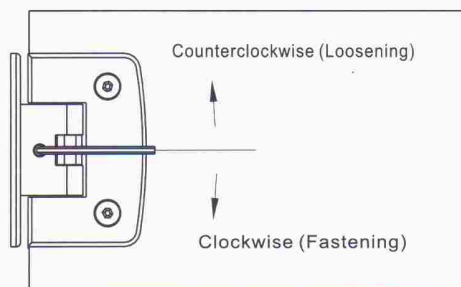
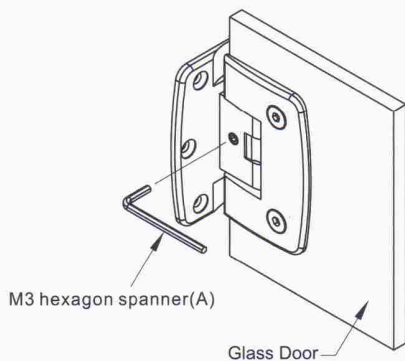
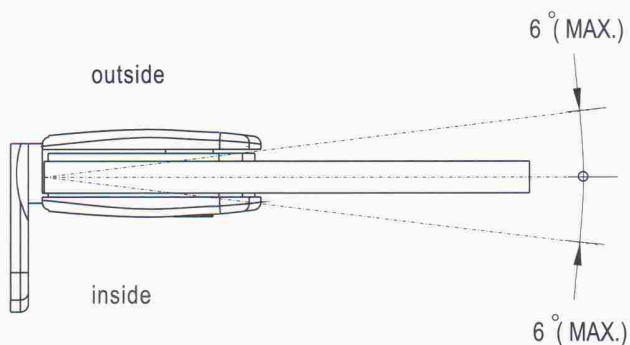

ADJUSTABLE HINGE AH

Adjustable Hinge



AH400C SERIES

Material: Brass
PATENT RIGHT

Maximum Capacities	6mm (1 / 4")		8mm (5 / 16")	
	Weight	Door Width	Weight	Door Width
Using 2 Hinges	25kgs (55 / lbs)	762mm (30")	25kgs (55 / lbs)	762mm (30")
Using 3 Hinges	40kgs (85 / lbs)	915mm (36")	40kgs (85 / lbs)	915mm (36")

UNIT:mm



AH400C

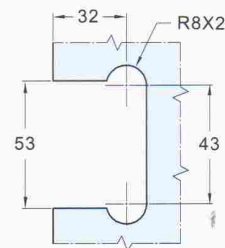
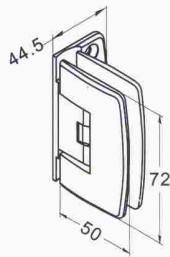

AH401C

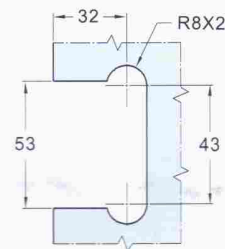
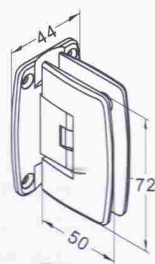

AH402C

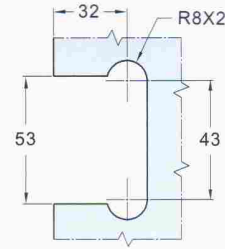
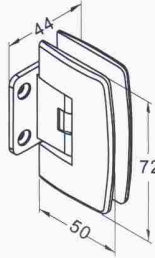

AH403C

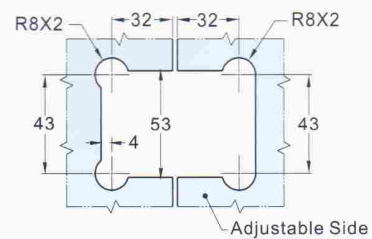
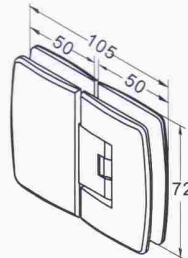

AH404C

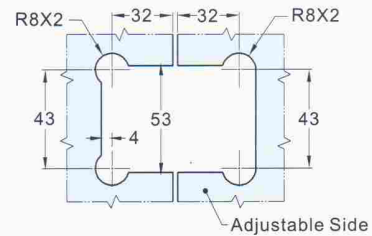
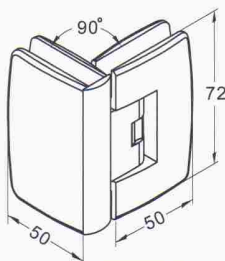

AH405C

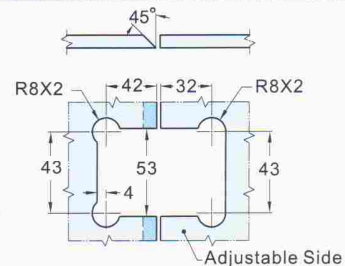
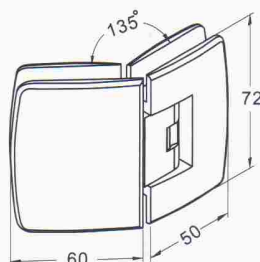

Adjustable Hinge



AH600G SERIES

Material: Brass

PATENT RIGHT

UNIT:mm

Maximum Capacities	10mm (3 / 8")		12mm (1 / 2")	
	Weight	Door Width	Weight	Door Width
Using 2 Hinges	43kgs (95 / lbs)	864mm (34")	43kgs (95 / lbs)	864mm (34")
Using 3 Hinges	60kgs (130 / lbs)	965mm (38")	60kgs (130 / lbs)	965mm (38")



AH600G

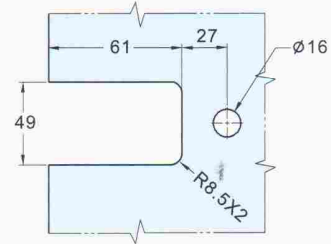
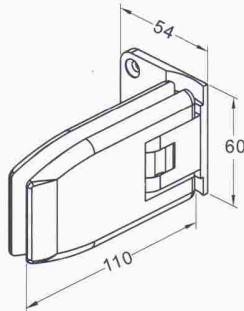

AH601G

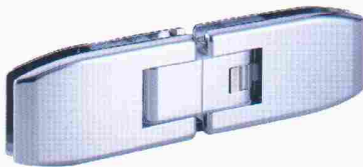
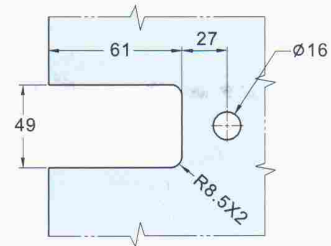
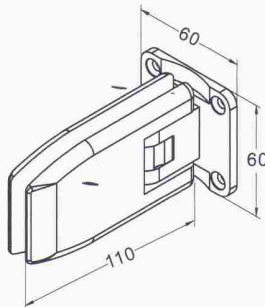

AH603G

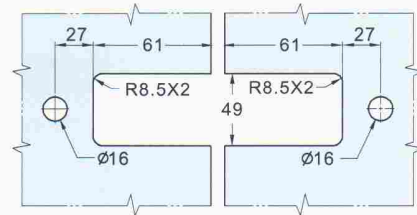
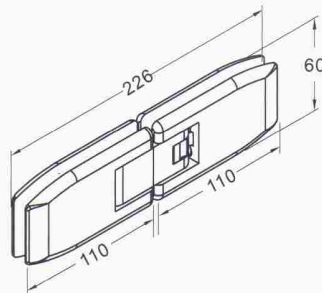

AH604G

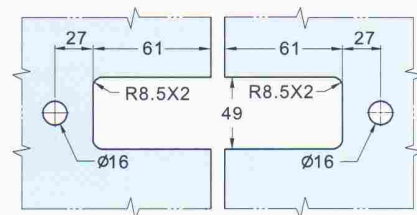
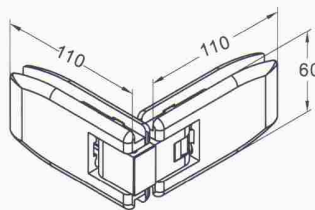

AH605G

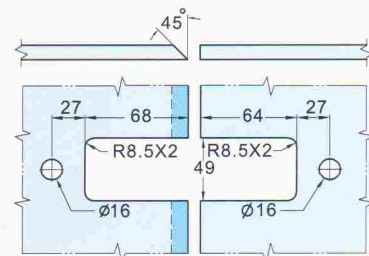
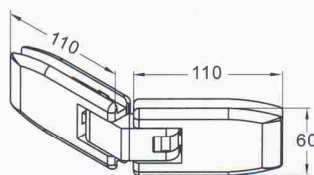

ADJUSTABLE HINGE AH



AH500B series



AH500S series



AH500C series



AH700B series



AH700C series

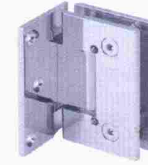

AH700S series



AH700G series

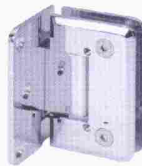

AH800B series

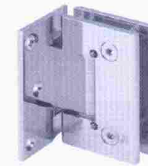

AH800S series



AH800C series

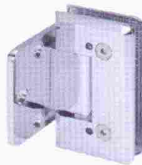

AH900B series



AH900S series

ADJUSTMENT SPECIFICATION SHEET

STEPS:

1. Use M3 Allen Key(A) to unfasten 2 screws(B) by turning 1 circle possibly then proceed with the adjustment.
2. After done with the angle adjustment, fasten 2 screws(B) tightly.

Adjustment Angle

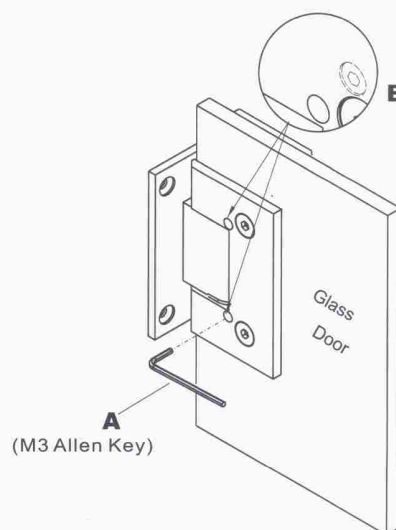
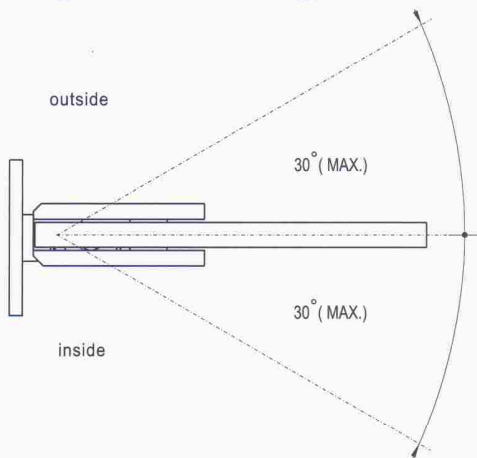

Adjustable Hinge

AH500B/S SERIES

Material: Brass

PATENT RIGHT

UNIT:mm

Maximum Capacities

	10mm (3 / 8")		12mm (1 / 2")	
	Weight	Door Width	Weight	Door Width
Using 2 Hinges	55kgs (120 / lbs)	813mm (32")	55kgs (120 / lbs)	813mm (32")



AH500B

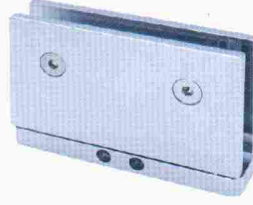

AH500S

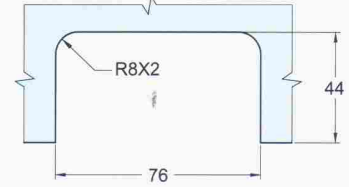
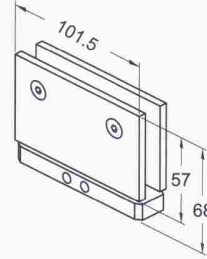

AH501B-R

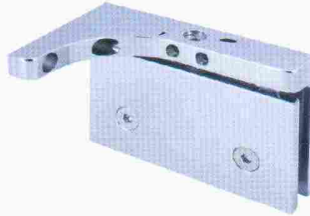

AH501S-R

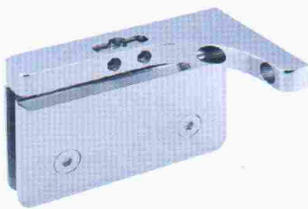
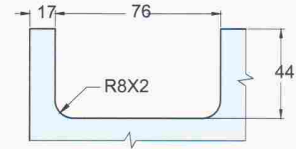
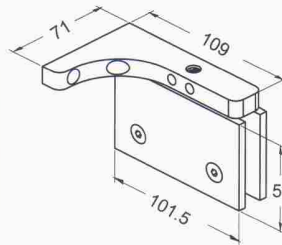

AH501B-L

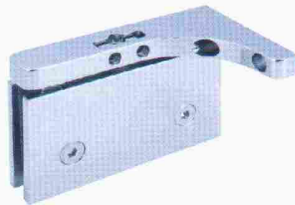

AH501S-L

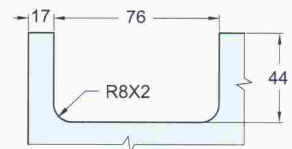
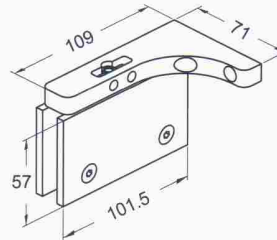

AH503B



AH503S

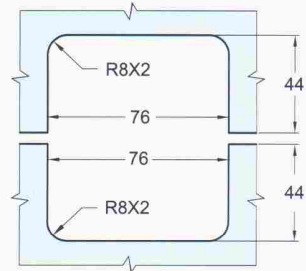
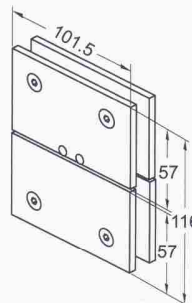

Adjustable Hinge



AH700B/C/S

SERIES

Material: Brass

PATENT RIGHT

UNIT:mm

Maximum Capacities	8mm (5 / 16")		10mm (3 / 8")	
	Weight	Door Width	Weight	Door Width
Using 2 Hinges	36kgs (80 / lbs)	762mm (30")	36kgs (80 / lbs)	762mm (30")
Using 3 Hinges	55kgs (120 / lbs)	915mm (36")	55kgs (120 / lbs)	915mm (36")



AH700B



AH700C

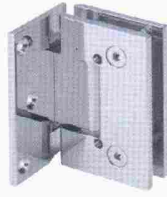

AH700S

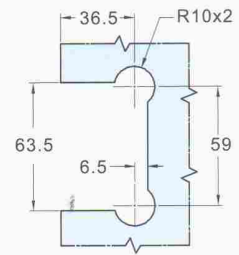
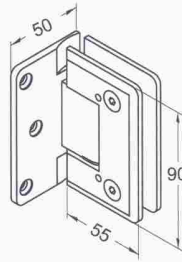

AH701B



AH701C



AH701S

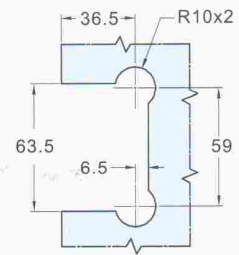
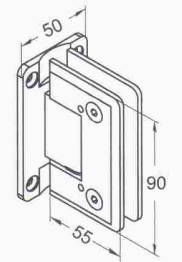

AH702B



AH702C



AH702S

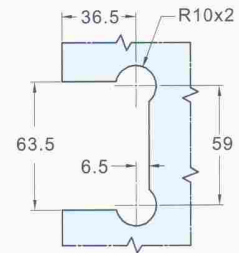
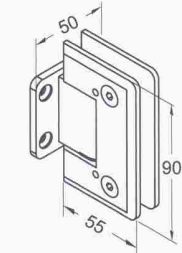

AH703B



AH703C



AH703S

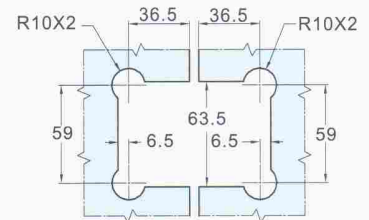
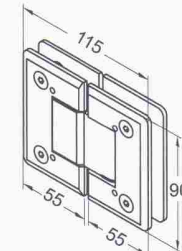

AH704B



AH704C



AH704S

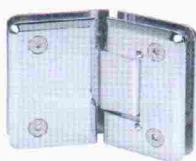
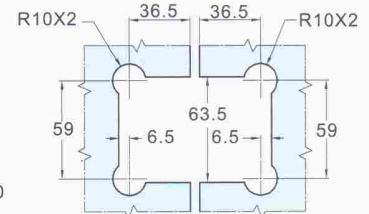
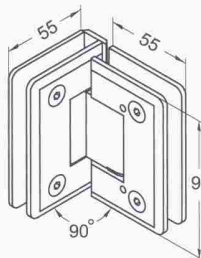

AH705B



AH705C



AH705S

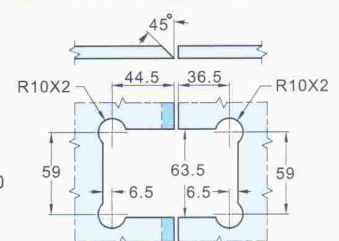
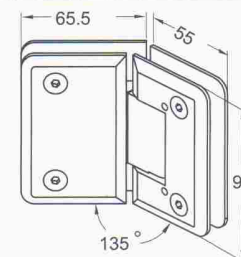

ADJUSTABLE HINGE AH

Adjustable Hinge

AH700G SERIES

Material: Brass
PATENT RIGHT

UNIT:mm

Maximum Capacities	8mm (5 / 16")		10mm (3 / 8")	
	Weight	Door Width	Weight	Door Width
Using 2 Hinges	36kgs (80 / lbs)	762mm (30")	36kgs (80 / lbs)	762mm (30")
Using 3 Hinges	55kgs (120 / lbs)	915mm (36")	55kgs (120 / lbs)	915mm (36")



AH700G

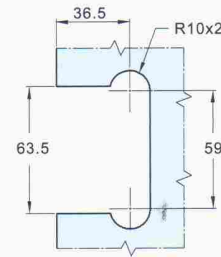
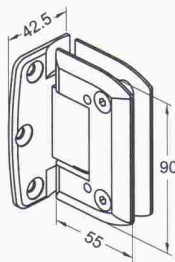

AH701G

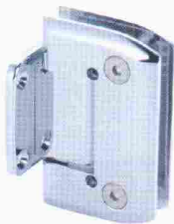
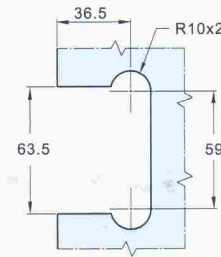
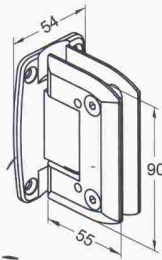

AH702G

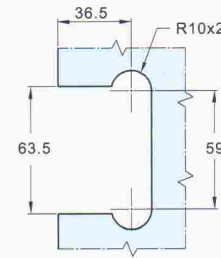
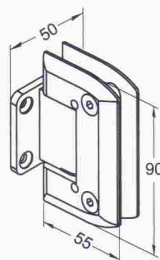

AH703G

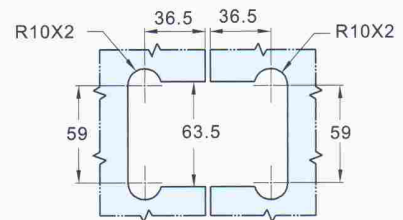
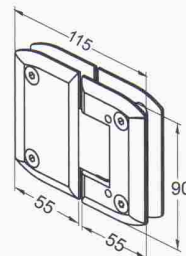

AH704G

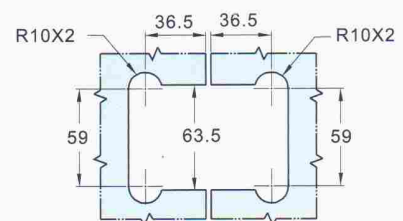
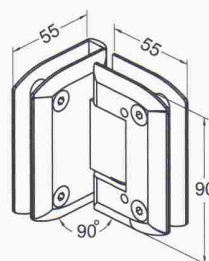

AH705G

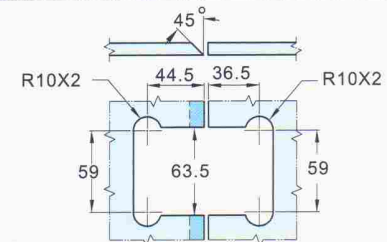
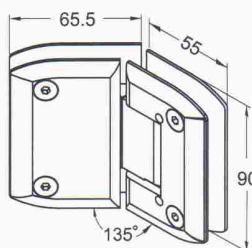

Material	Material No.	Cover Finish
Stainless Steel	SUS316	PSS,BSS

PSS: Polished Stainless Steel
BSS: Brushed Stainless Steel

Maximum Door Weight : 50kgs (110 lbs)
For 8mm(5/16")~10mm(3/8") Glass

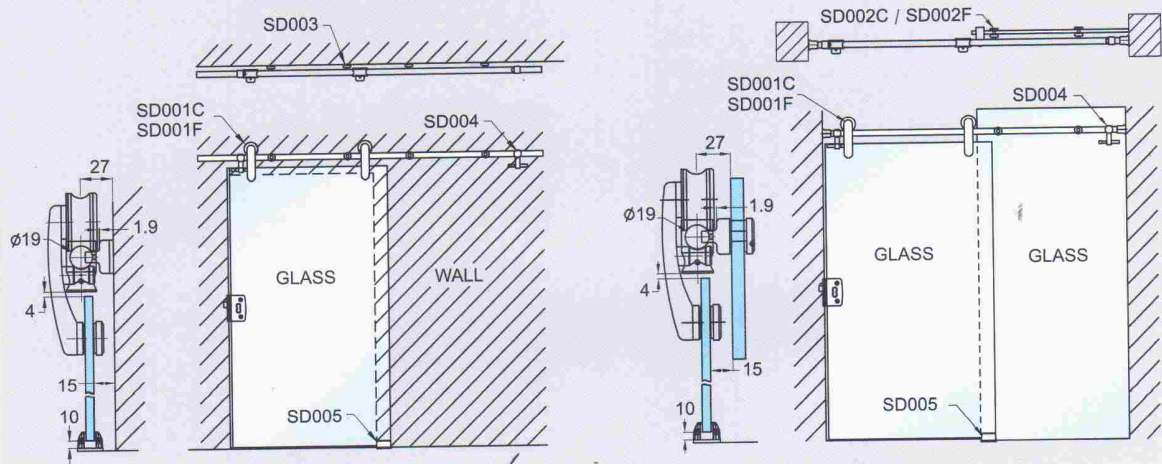

UNIT:mm

SD001C Countersink Type

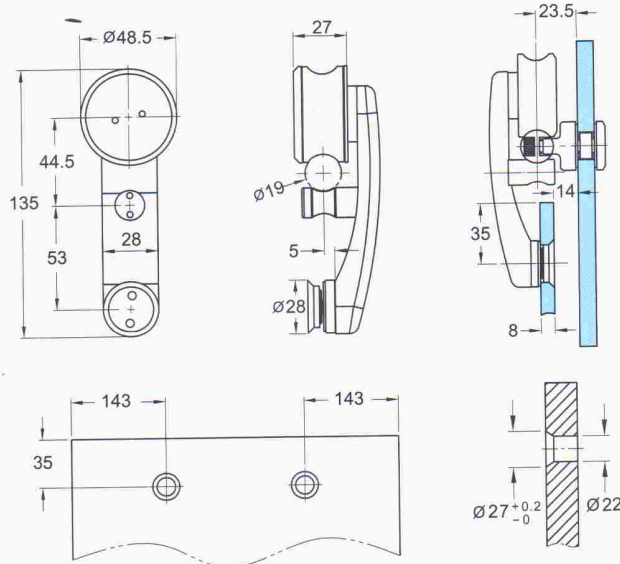

SD001F Flat Type

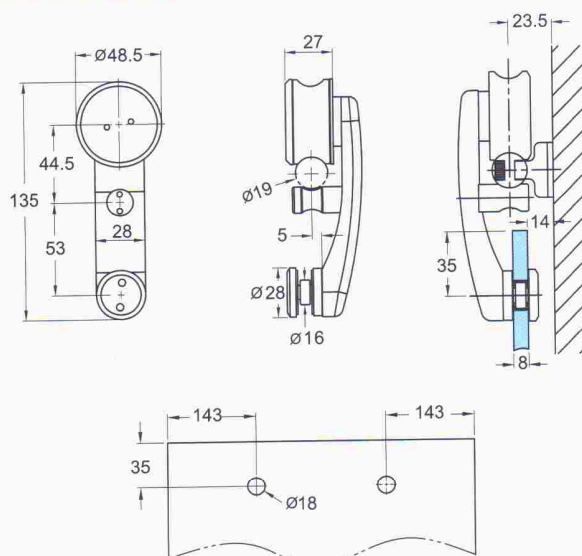
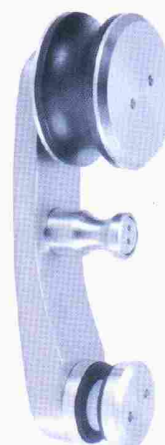

UNIT:mm

SD002C

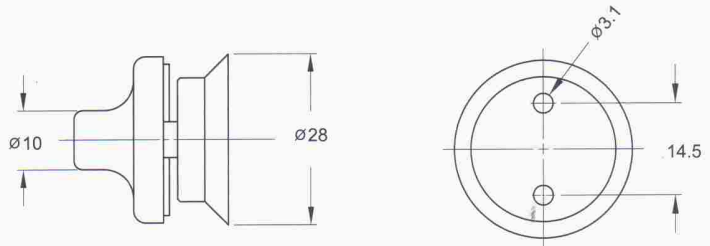

SD002F

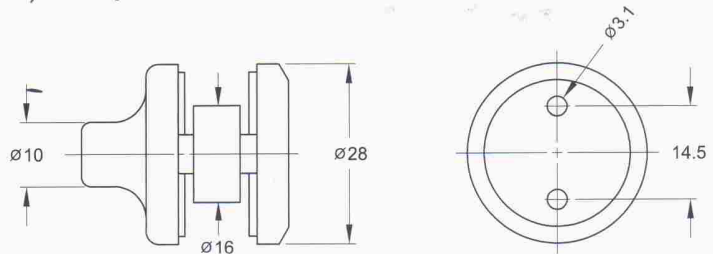

SD003

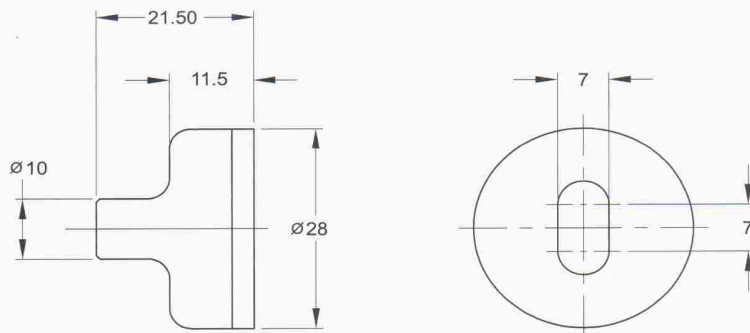

SD004

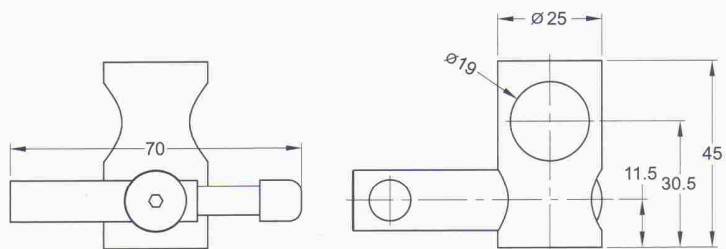
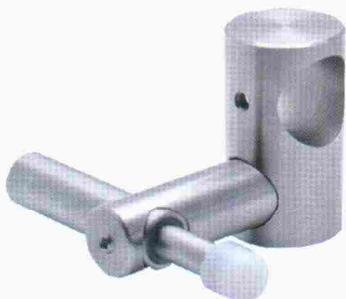

Sliding Door

For Glass 8mm (5/16") ~ 10mm (3/8").

UNIT:mm



SD701C NEW
Material : Brass

SD701E NEW
Material : Brass



SD702 NEW
Material : Brass

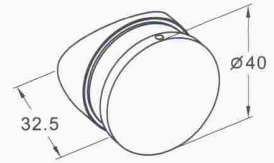

SD703 NEW
Material : Brass

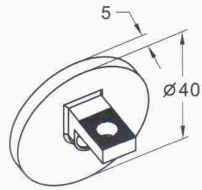

SD704 NEW
Material : Brass

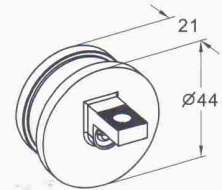

SD705 NEW
Material : Brass

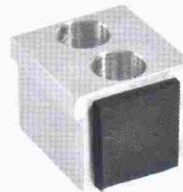
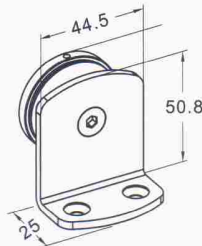

SD706 NEW
Material : Aluminium

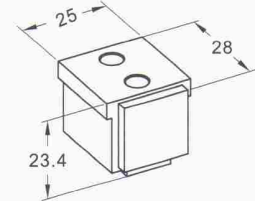

SD707 NEW

Material : Aluminium
Aluminium bar length 3000mm(Max.)
Finish : polish anodised / brush anodised

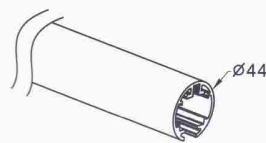

SD500

Material : Zinc
Finish : AN,PSC
For 8mm(5/16")~12mm(1/ 2") Glass
© You may apply this item in commerical door series

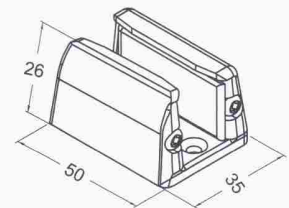

SDK02

Material : SUS316/Brass/Aluminium
For 10mm(3/8")~12mm(1/ 2")Glass
© You may apply this item in commerical door series

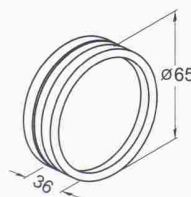

About door lock , Please take referece
for Indication Lock Series

SLIDING DOOR
SD

Sliding Door



Max. Door Weight: 40Kgs
Max. Door Width : 1000mm
Max. Door Hight : 2000mm

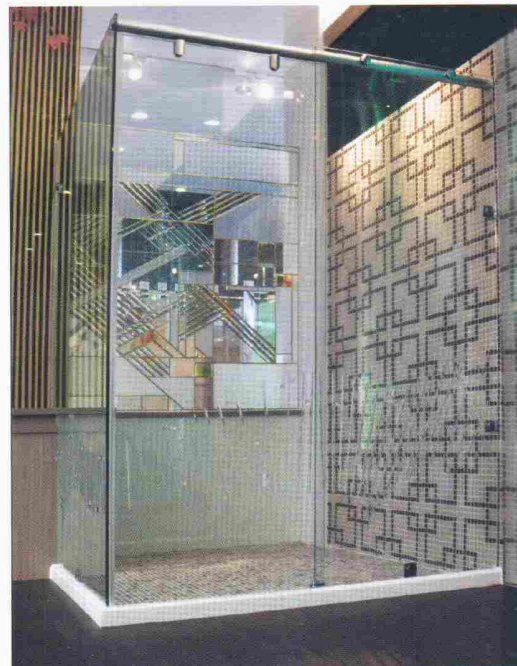
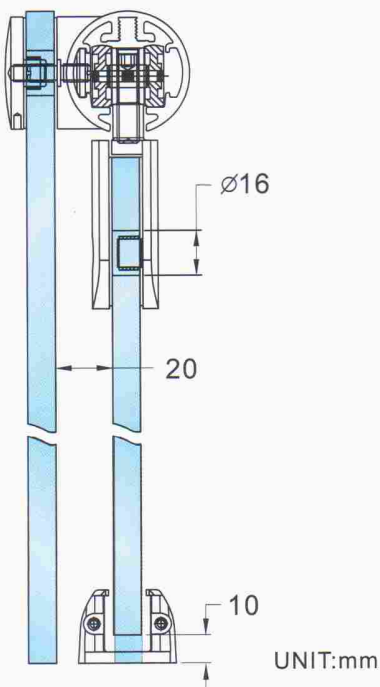
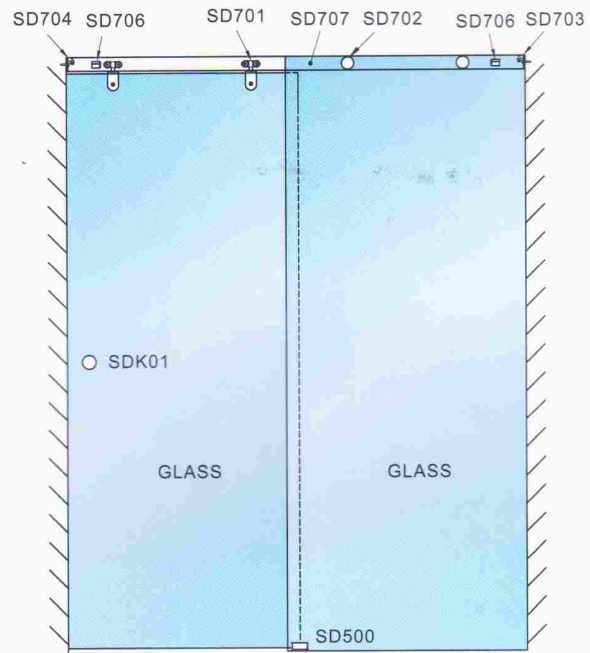
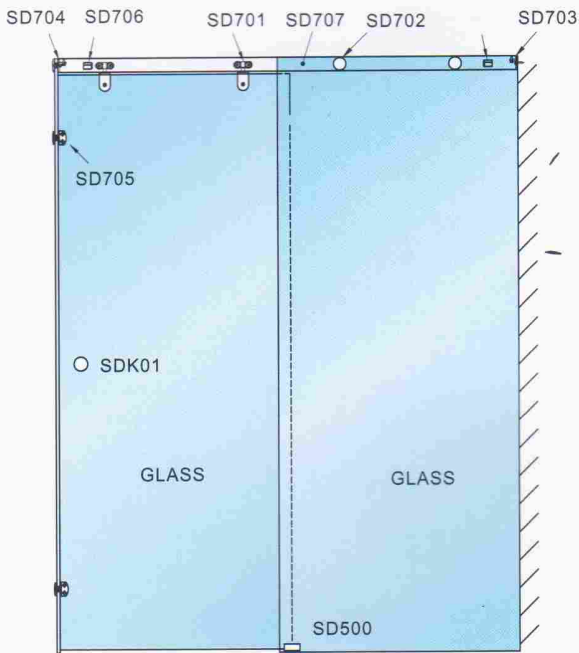
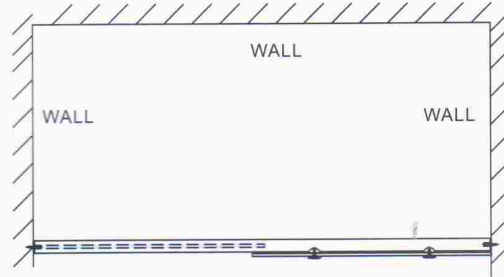
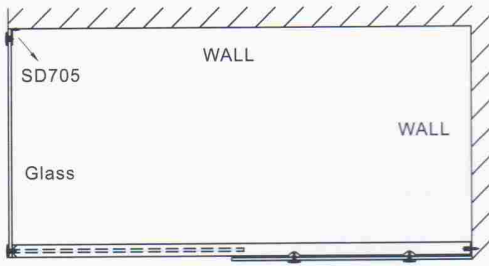

SLIDING DOOR
SD

Indication Lock

Material: Brass

PATENT RIGHT

For 8mm (5/16") ~ 12mm(1/2") glass

UNIT:mm



IL700C



IL700G



ILH700C



KL700C NEW



IL700S NEW



GL700C



GL700G

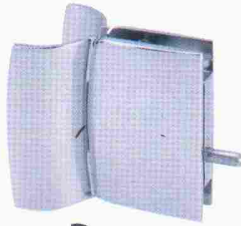

GLH700C

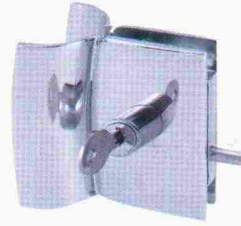

KLH700C NEW



ILH700S NEW

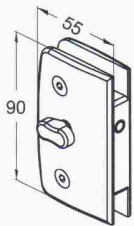

IL700C/G
GL700C/G
KL700C

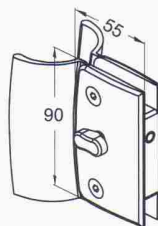

ILH700C
GLH700C
KLH700C

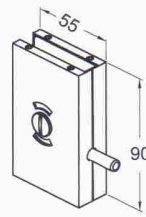

IL700S

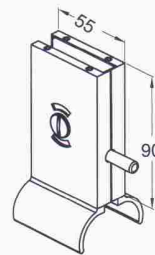

ILH700S

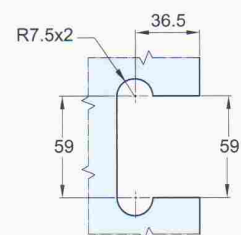

IL/ILH700
GL/GLH700
KL/KLH700



IL700C-KEEPER



IL701C-KEEPER



IL701G-KEEPER



IL702C-KEEPER

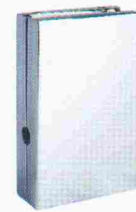

IL701S-KEEPER NEW

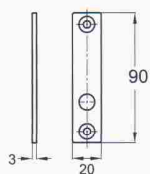

IL700C-KEEPER

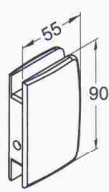

IL701C/G-KEEPER

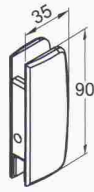

IL702C-KEEPER

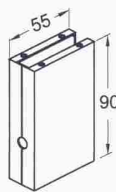

IL701S-KEEPER

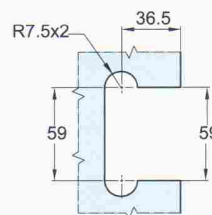

IL701C/G/S-KEEPER

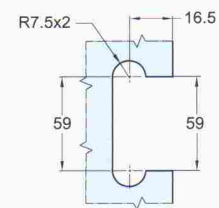

IL702C-KEEPER

Indication Lock



Material: Brass

PATENT RIGHT

For 8mm (5/16") ~ 12mm(1/2") glass

UNIT:mm



IL700C-H



IL700G-H



ILH700C-H



KL700C-H NEW



GL700C-H



GL700G-H



GLH700C-H



KLH700C-H NEW

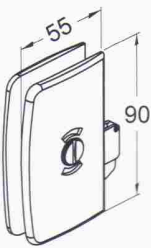

IL700C/G-H
GL700C/G-H

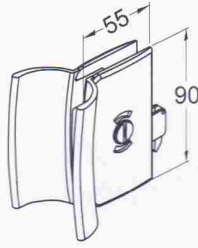

ILH700C/G-H
GLH700C/G-H

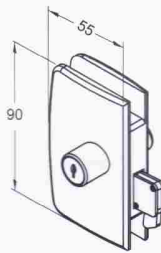

KL700C-H

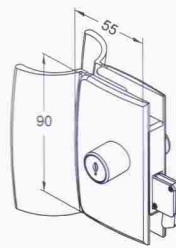

KLH700C-H

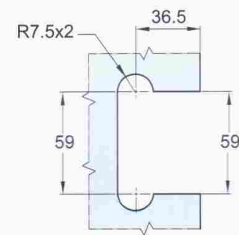

IL/ILH700-H
GL/GLH700-H
KL/KLH700-H



**IL700C-H
KEEPER**



**IL701C-H
KEEPER**



**IL701G-H
KEEPER**



**IL702C-H
KEEPER**

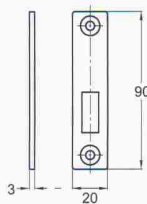

IL700C-H
KEEPER

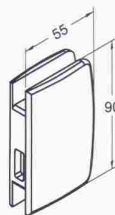

IL701C/G-H KEEPER

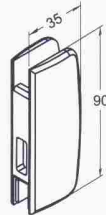

IL702C-H KEEPER

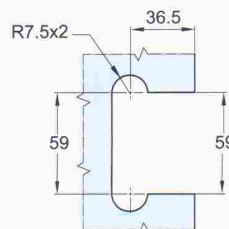

IL701C/G-H KEEPER

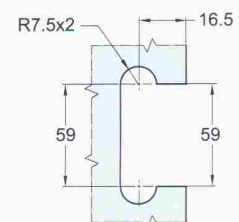

IL702C-H KEEPER

Indication Lock



Material: Brass

PATENT RIGHT

For 8mm(5/16")~10mm(3/8") glass

UNIT:mm



IL600C



GL600C



KL600C

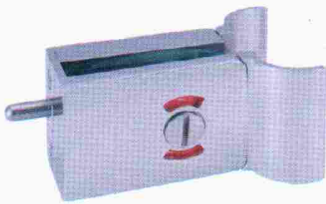

ILH600C



GLH600C



KLH600C

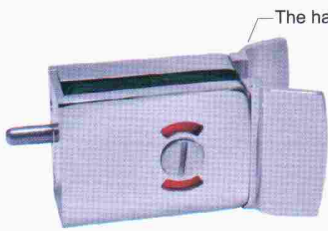

ILH600C-N NEW

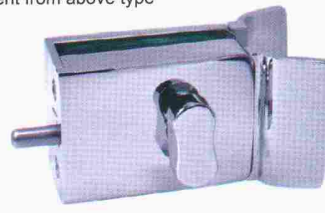

GLH600C-N NEW



KLH600C-N NEW

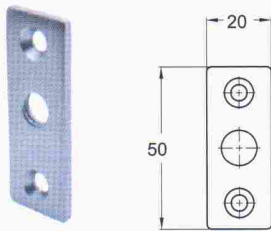

IL600C-KEEPER



IL601C-KEEPER



IL602C-KEEPER

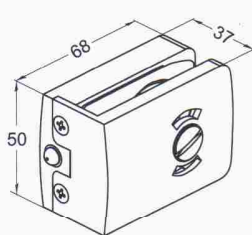

IL600C/GL600C/KL600C
IL601C-KEEPER

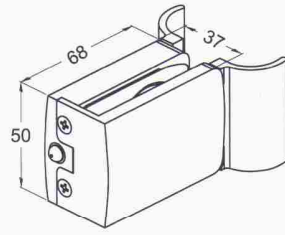

ILH600C/GLH600C/KLH600C
ILH600C-N/GLH600C-N/KLH600C-N

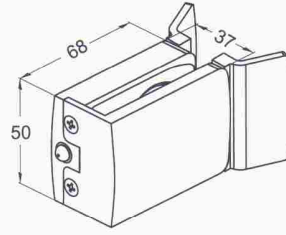

IL601C-N/GLH600C-N/
KLH600C-N

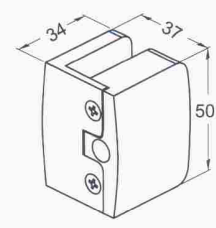

IL602C-KEEPER

Shower Handle

UNIT : mm

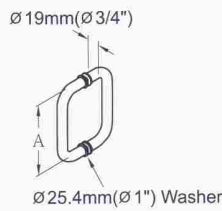

No Washers			With Washers		
Item No.	D	A	Item No.	D	A
SP701A	19	6"(152.4mm)	SP701AW	19	6"(152.4mm)
SP701B	19	8"(203.2mm)	SP701BW	19	8"(203.2mm)

Material : Brass or stainless steel
 Tube or solid Diameter : 19mm (3/4")
 For 6mm (1/4") ~ 12mm (1/2") glass

PUSH-PULL HANDLE

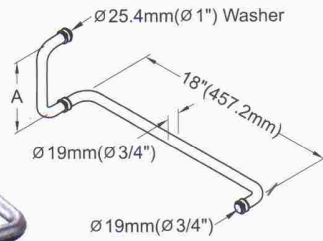

No Washers		With Washers	
Item No.	A	Item No.	A
SP702A	6"(152.4mm)	SP702AW	6"(152.4mm)
SP702B	8"(203.2mm)	SP702BW	8"(203.2mm)

Material : Brass or stainless steel
 Tube or solid Diameter : 19mm (3/4")
 For 6mm (1/4") ~ 12mm (1/2") glass

COMBO

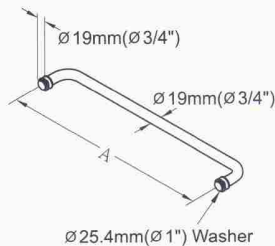

No Washers		With Washers	
Item No.	A	Item No.	A
TB701C	12"(304.8mm)	TB701CW	12"(304.8mm)
TB701D	16"(406.4mm)	TB701DW	16"(406.4mm)
TB701E	18"(457.2mm)	TB701EW	18"(457.2mm)
TB701F	20"(508.0mm)	TB701FW	20"(508.0mm)
TB701G	22"(558.8mm)	TB701GW	22"(558.8mm)
TB701H	24"(609.6mm)	TB701HW	24"(609.6mm)

Material : Brass or stainless steel
 Tube or solid Diameter : 19mm (3/4")
 For 6mm (1/4") ~ 12mm (1/2") glass

TOWEL BAR(SINGLE)

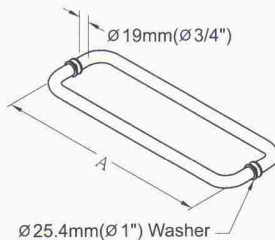

No Washers		With Washers	
Item No.	A	Item No.	A
TB702C	12"(304.8mm)	TB702AW	12"(304.8mm)
TB702E	18"(457.2mm)	TB702BW	18"(457.2mm)
TB702H	24"(609.6mm)	TB702CW	24"(609.6mm)

Material : Brass or stainless steel
 Tube or solid Diameter : 19mm (3/4")
 For 6mm (1/4") ~ 12mm (1/2") glass

TOWEL BAR(BACK TO BACK)

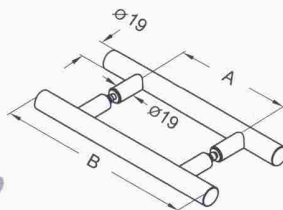
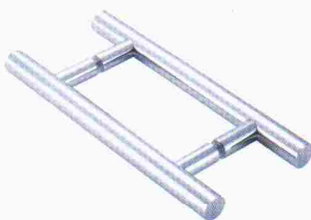

Item No.	A	B
MF150	150	250
MF250	250	350

MF150/MF250

Material : Brass/stainless steel

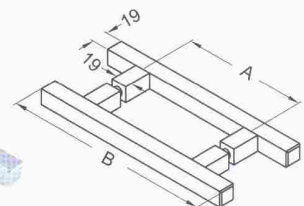
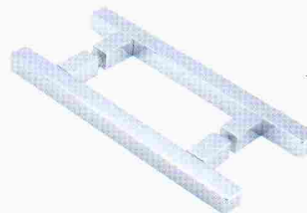

Item No.	A	B
MFS150	150	250
MFS250	250	350

MFS150/MFS250

Material : Brass

Knob

For 6mm (1/4") ~ 12mm(1/2") glass

Material: Brass or Stainless steel or Aluminium

UNIT : mm

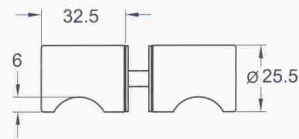

KN301

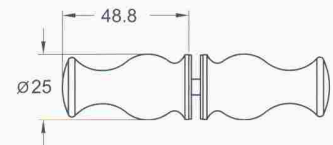

KN302

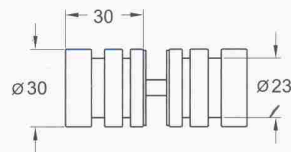

KN303

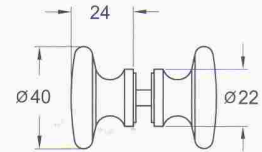
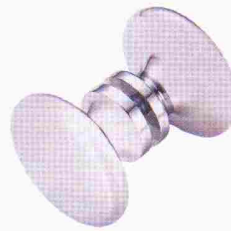

KN304

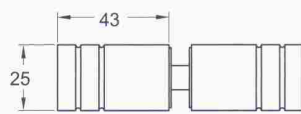

KN305

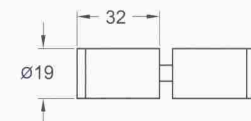

KN306

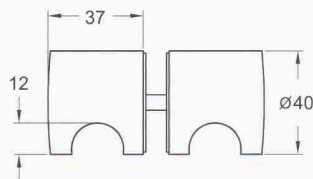

KN307

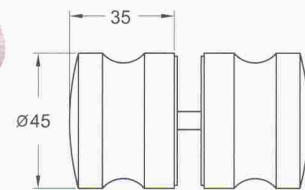
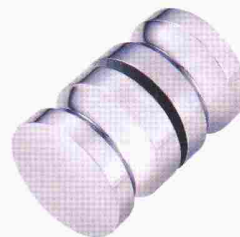

KN308

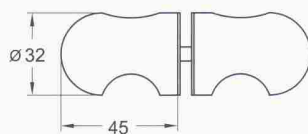

KN309

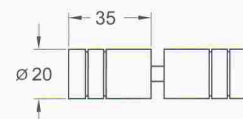

KN310

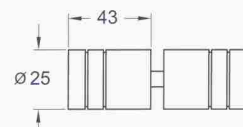

KN311

Support Bar Assemble

1.Bar Diameter: \varnothing 19mm

2.Brass Bar Length 1000mm(Max.)

3.For 6mm (1/4") ~ 12mm(1/2") glass

Material : Brass or Stainless steel

UNIT : mm

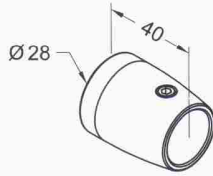

SB001

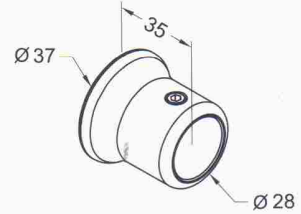

SB002

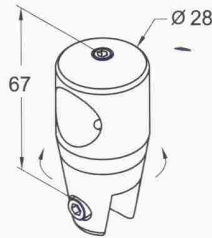

SB003

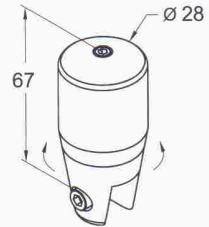

SB004

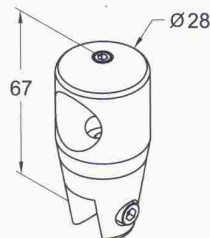

SB005(None Angle)

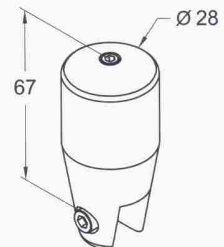

SB006(None Angle)

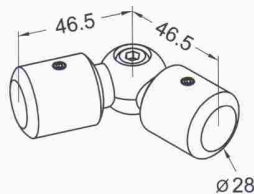

SB007

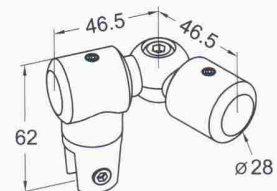

SB008

Support Bar Assemble



- 1. Bar Diameter: $\varnothing 19\text{mm}$
 - 2. Brass Bar Length 1000mm(Max.)
 - 3. For 6mm (1/4") ~ 12mm (1/2") glass
- Material :** Brass or Stainless steel

UNIT : mm



SB009

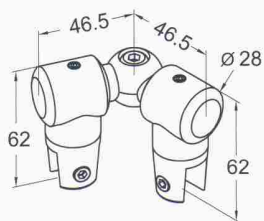

SB010

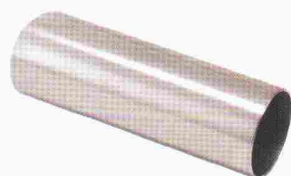
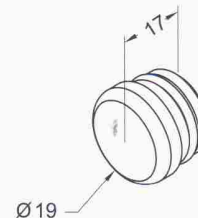

SB011 NEW
Length 1000mm(Max.)

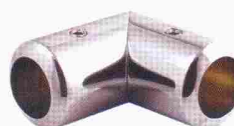
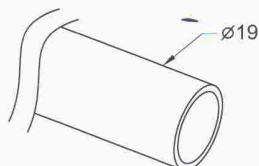

SB012 NEW

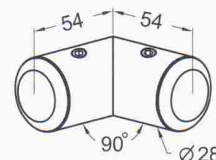

SB013 NEW

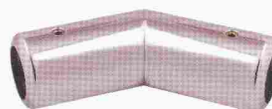
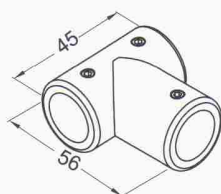

SB014 NEW

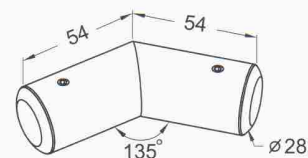

SB015 NEW

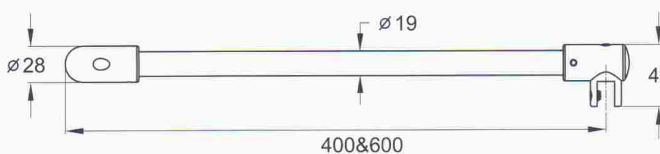

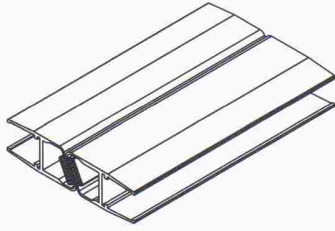

MS0608-3

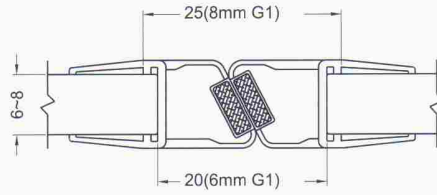

Glass thickness 6mm ,8mm

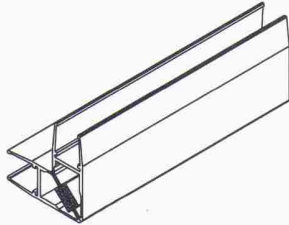

MS0608-4

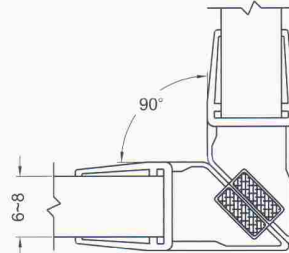

Glass thickness 6mm ,8mm

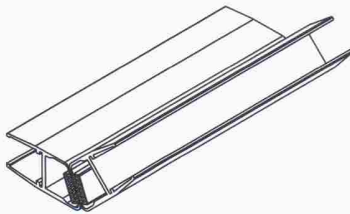

MS0608-5

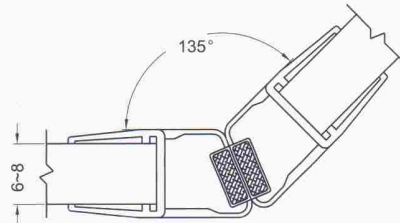

Glass thickness 6mm ,8mm

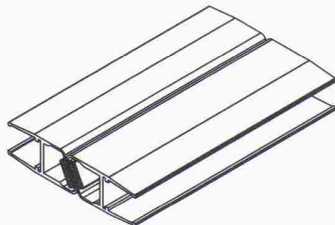

MS0810-3

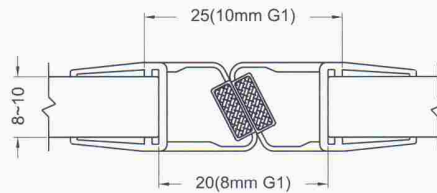

Glass thickness 8mm ,10mm

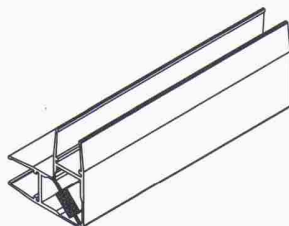

MS0810-4

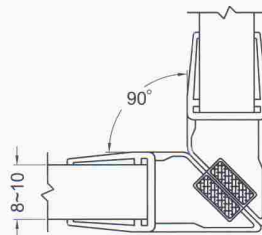

Glass thickness 8mm ,10mm

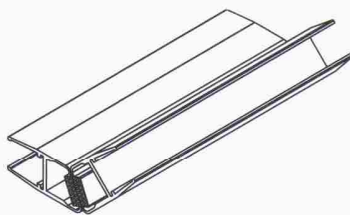

MS0810-5

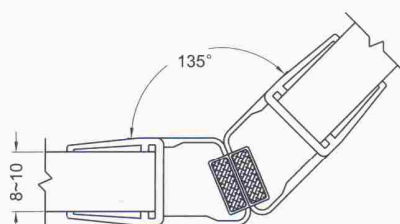

Glass thickness 8mm ,10mm

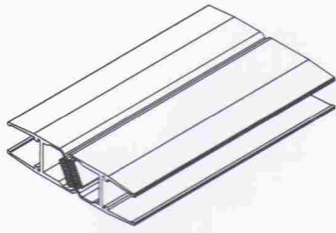

MS1012-3

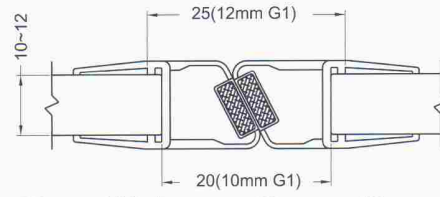

Glass thickness 10mm ,12mm

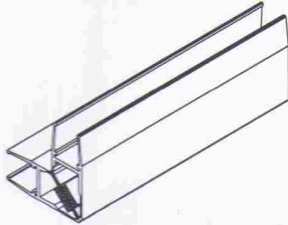

M1012-4

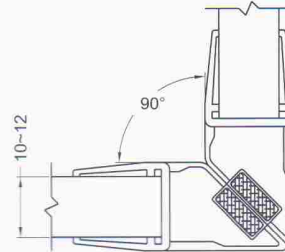

Glass thickness 10mm ,12mm

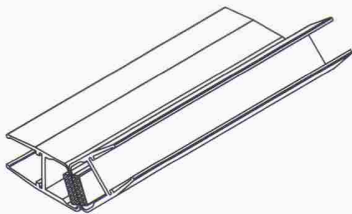

MS1012-5

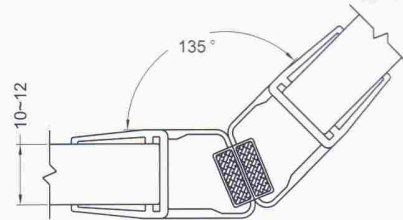

Glass thickness 10mm ,12mm

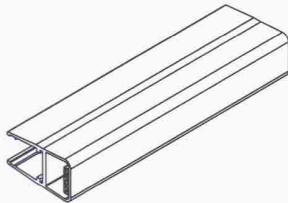

MS0608S

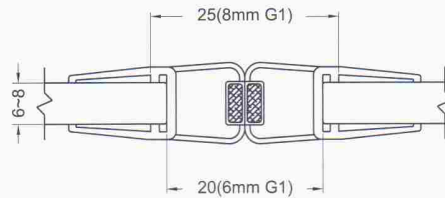

Glass thickness 6mm ,8mm

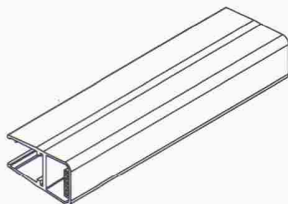

MS0810S

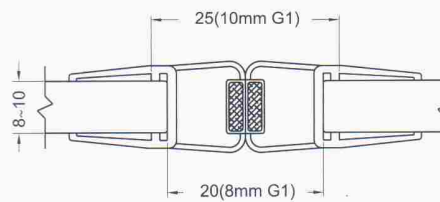

Glass thickness 8mm ,10mm

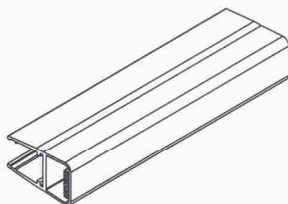

MS1012S

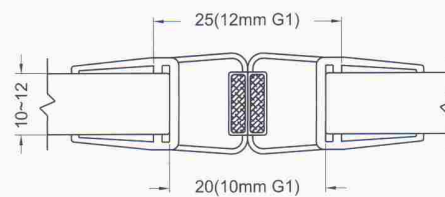

Glass thickness 10mm ,12mm

WS101-08(for 8mm Glass)
WS101-10(for 10mm Glass)
Bottom Gasket

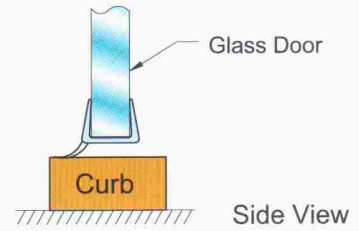
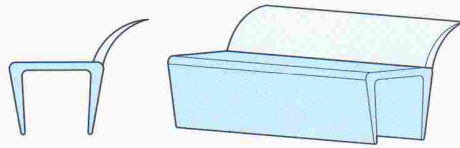

WS102-08(for 8mm Glass)
WS102-10(for 10mm Glass)
Bottom Gasket

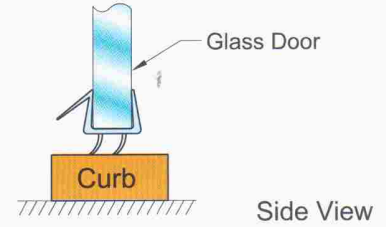
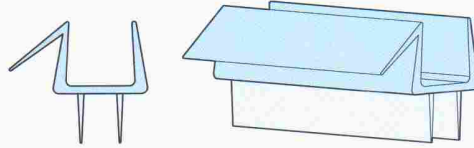

WS103-08(for 8mm Glass)
WS103-10(for 10mm Glass)
Glass to Glass 180°

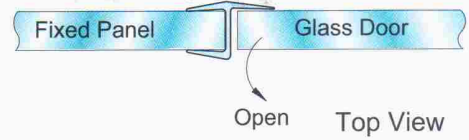
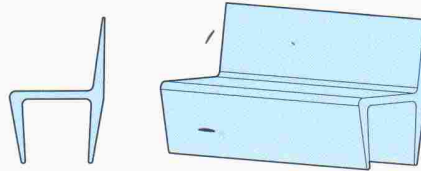

WS104-08(for 8mm Glass)
WS104-10(for 10mm Glass)
Glass to Glass 90°

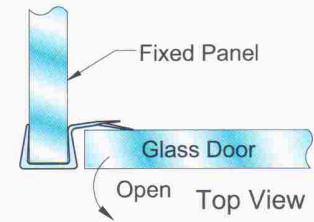
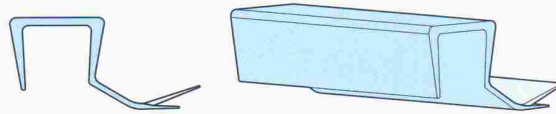

WS105-08(for 8mm Glass)
WS105-10(for 10mm Glass)
Glass to Glass 135°

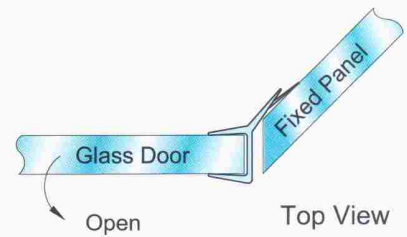
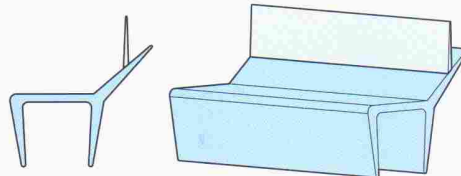

WS106-08(for 8mm Glass)
WS106-10(for 10mm Glass)
Bottom Gasket

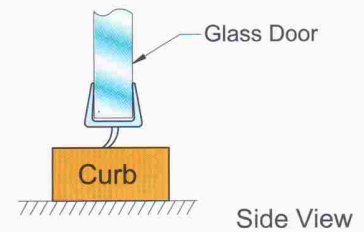
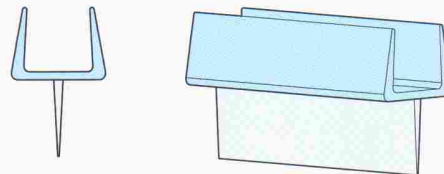

WS107-08(for 8mm Glass)
WS107-10(for 10mm Glass)
Sided Gasket

